







#### CARE AND MAINTENANCE

Store outdoor furniture indoors or cover well when it is not in use.  
Dust regularly with small brush or vacuum. Spills should be taken care of immediately before they harden or stain with a slightly dampened sponge.

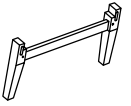
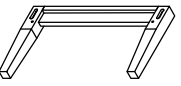
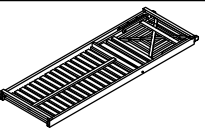
#### NOTICE

Please make sure that you have all parts indicated before you begin assembly of this item.

### Part List and Hardware List

| PIECE     | DESCRIPTION | PICTURE  | QUANTITY   |
|-----------|-------------|--|------------|
| <b>A</b>  | Front leg   |           | <b>1 X</b> |
| <b>B</b>  | Rear leg    |           | <b>1 X</b> |
| <b>C</b>  | Seat        |           | <b>1 X</b> |
| <b>D1</b> | Allen bolt  | <br>M6x80 | <b>4 X</b> |
| <b>D2</b> | Allen nut   | <br>M6x90 | <b>4 X</b> |
| <b>D3</b> | Bolt extra  | <br>M6x50 | <b>1 X</b> |
| <b>D4</b> | Wrench      |           | <b>1 X</b> |
| <b>D5</b> | Allen key   |         | <b>1 X</b> |

 **SAFAVIEH**  
OUTDOOR

MODEL # PAT6730

Product Dimension: 60.63"Wx34.65"Dx15"H

Weight capacity : 600 lbs.

Warning : Do not stand on the lounger

Warning : Do not torque bolts / screws



**! WARNING !**



Before beginning the assembly of the product, make sure all parts are present. Compare the parts with package contents list and hardware contents list. If any parts are missing or damaged, do not attempt to assemble the product. Tool required for assembly (included): Allen key and Wrench.

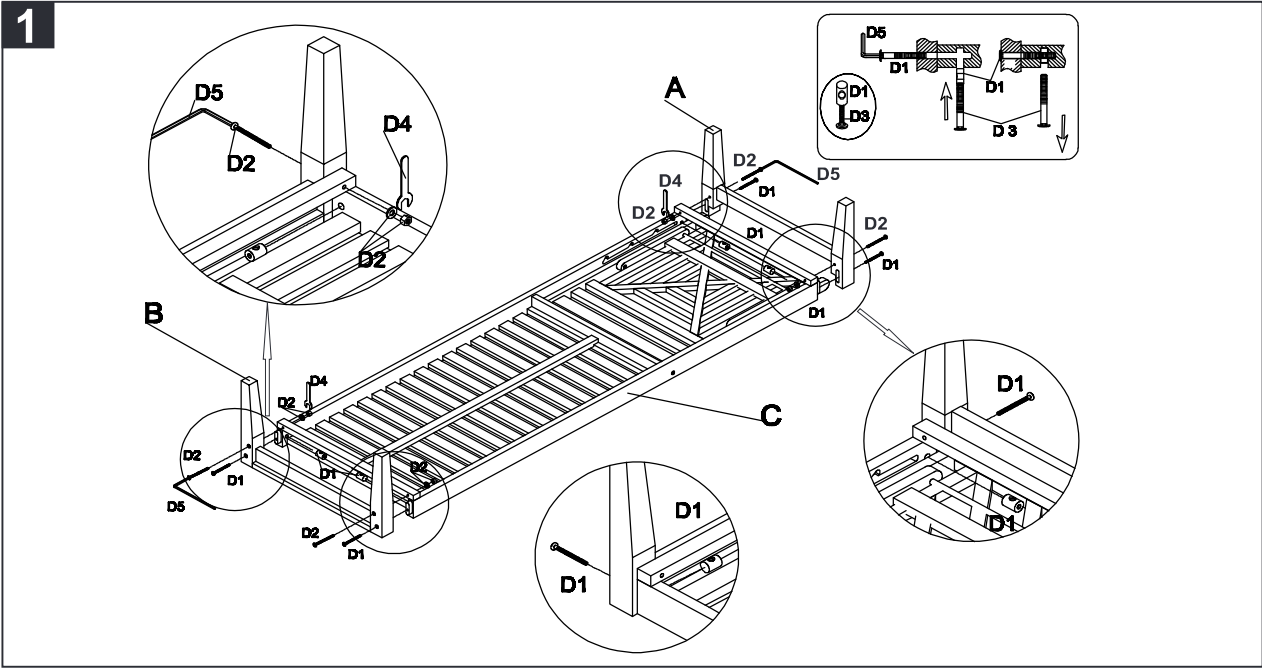

Step1: attach the rear leg (A) to the seat (C) as shown on the picture by using the Allen bolt (D1) and Allen nut (D2). Tighten all with the Allen key (D4) and Wrench (D5). Repeat the assembling of the front leg (B) in the same way as the rear leg (A). Tighten all bolts and screws again before use.