

Owner's Manual & Assembly Guide



Model No.

- CLG86CC
- CLG86FG
- CLG86BG
- CLG86SG

8' x 6'

Nominal Size

! caution

sharp edges *

Gloves must be worn at all times to reduce risk of injury!

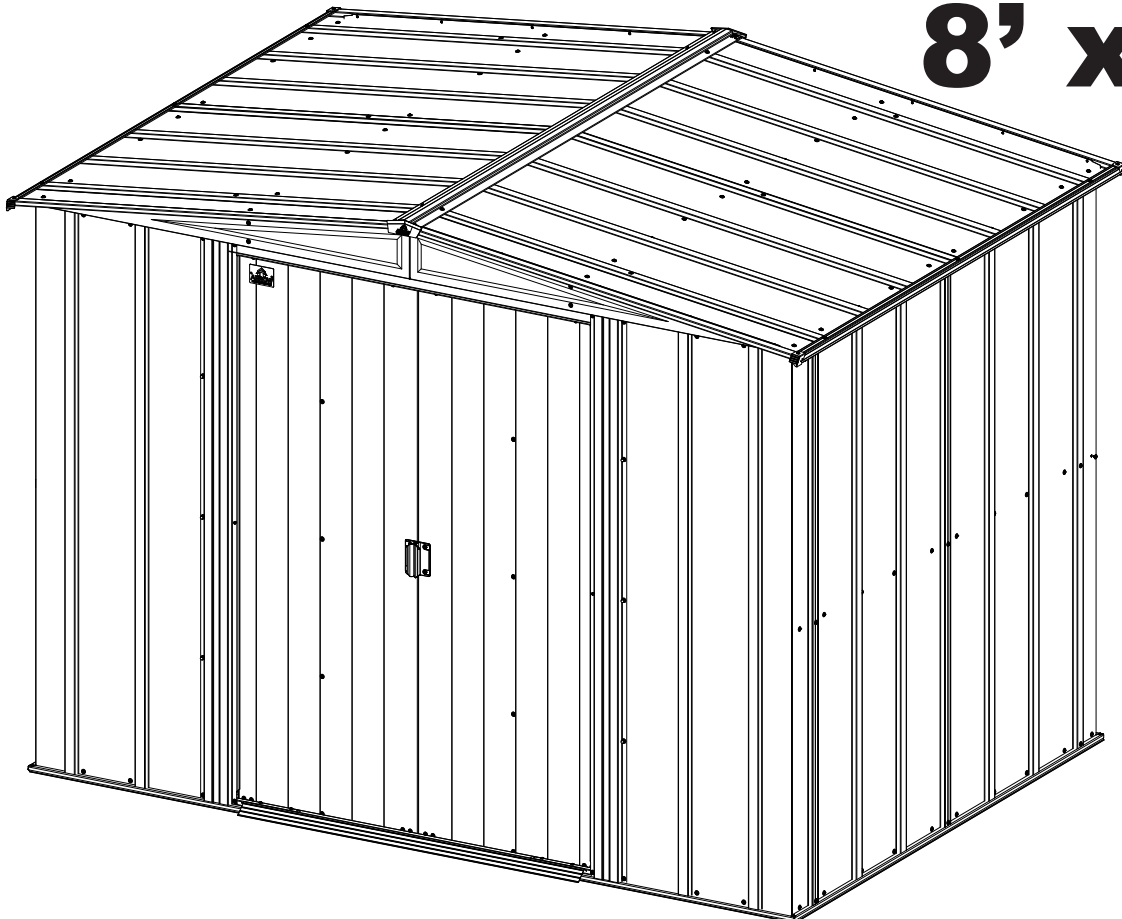

Base Size	97 1/2" x 68 3/4" 247,7 cm x 174,6 cm
------------------	--

BUILDING DIMENSIONS

†Size rounded off to the nearest foot

For proper base construction see page 12

Approx.† Size	Storage Area	Exterior Dimensions (Roof Edge to Roof Edge)			Interior Dimensions (Wall to Wall)			Door Opening	
		Width	Depth	Height	Width	Depth	Height	Width	Height
8' x 6'	43 Sq. Ft. 248 Cu. Ft.	99 3/4"	71 1/4"	72 7/8"	94 3/4"	66"	71 5/8"	43 1/2"	63"
2,4 m x 1,8 m	4,0 m ² 7,0 m ³	253,4 cm	181,0 cm	185,1 cm	240,7 cm	167,6 cm	181,9 cm	110,5 cm	160,0 cm

* See Inside for Detailed Safety Information.

Manuel de l'utilisateur et guide d'assemblage

Taille de la base

97 1/2" x 68 3/4"
247,7 cm x 174,6 cm

DIMENSIONS DU COFFRE



†Dimension arrondie au pied le plus proche

Taille † approx.	Zone d'entreposage		Dimensions extérieures (de bordure de toit à bordure de toit)			Dimensions intérieures (de paroi à paroi)			Ouverture de porte	
			Largeur	Profondeur	Hauteur	Largeur	Profondeur	Hauteur	Largeur	Hauteur
8' x 6'	43 Sq. Ft.	248 Cu. Ft.	99 3/4"	71 1/4"	72 7/8"	94 3/4"	66"	71 5/8"	43 1/2"	63"
2,4 m x 1,8 m	4,0 m ²	7,0 m ³	253,4 cm	181,0 cm	185,1 cm	240,7 cm	167,6 cm	181,9 cm	110,5 cm	160,0 cm

* Voir les informations de sécurité détaillées à l'intérieur.

Manual del propietario e instrucciones de ensamblaje

Tamaño básico

97 1/2" x 68 3/4"
247,7 cm x 174,6 cm

DIMENSIONES DE LA UNIDAD



† Las medidas están redondeadas en pies

Tamaño † aproximado	Área de almacenaje		Dimensiones exteriores (borde a borde del techo)			Dimensiones interiores (pared a pared)			Abertura de la puerta	
			Ancho	Profundidad	Altura	Ancho	Profundidad	Altura	Ancho	Altura
8' x 6'	43 Sq. Ft.	248 Cu. Ft.	99 3/4"	71 1/4"	72 7/8"	94 3/4"	66"	71 5/8"	43 1/2"	63"
2,4 m x 1,8 m	4,0 m ²	7,0 m ³	253,4 cm	181,0 cm	185,1 cm	240,7 cm	167,6 cm	181,9 cm	110,5 cm	160,0 cm

* Consulte en el interior para obtener la seguridad de información detallada.

Pflege- & Montageanleitung

Bodenabmessungen

97 1/2" x 68 3/4"
247,7 cm x 174,6 cm

ABMESSUNGEN



†Angaben auf ganze Fuß gerundet

Ungefähre † Größe	Lagerfläche		Außenabmessungen (Dachkante zu Dachkante)			Innenabmessungen (Wand zu Wand)			Türöffnung	
			Breite	Tiefe	Höhe	Breite	Tiefe	Höhe	Breite	Höhe
8' x 6'	43 Sq. Ft.	248 Cu. Ft.	99 3/4"	71 1/4"	72 7/8"	94 3/4"	66"	71 5/8"	43 1/2"	63"
2,4 m x 1,8 m	4,0 m ²	7,0 m ³	253,4 cm	181,0 cm	185,1 cm	240,7 cm	167,6 cm	181,9 cm	110,5 cm	160,0 cm

* Detaillierte Sicherheitsinformationen im Inneren.

CAUTION / ATTENTION / PRECAUCIONES/ VORSICHT

EN,FR,SP,GE-04HN

- Care must be taken when handling various pieces of your building since many contain sharp edges.
- Faire preuve de précaution pour manipuler les différentes pièces de l'abri car elles présentent de nombreux bords coupants.
- Tenga cuidado al manipular las diferentes piezas de la estructura ya que pueden tener bordes filosos.
- Verschiedene Teile Ihres Schuppens müssen vorsichtig gehandhabt werden, denn viele haben scharfe Kanten.

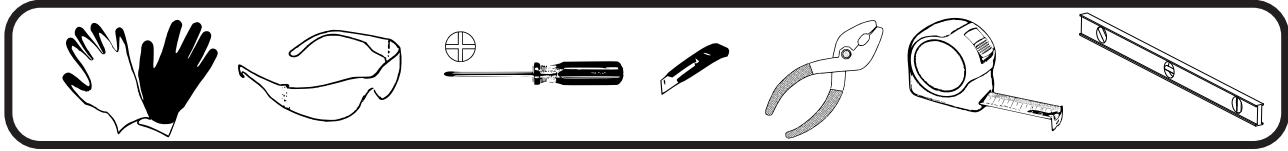

- Do NOT attempt to assemble your building before double checking that you have all the parts indicated in the parts lists. Any building left partially assembled may be seriously damaged by even light winds.
- Ne PAS tenter d'assembler l'abri avant d'avoir vérifié la présence de toutes les pièces figurant dans la liste des pièces. Tout abri laissé partiellement assemblé peut être gravement endommagé par des vents même légers.
- NO trate de montar la estructura antes de verificar que tenga todas las piezas indicadas en la lista de piezas. Cualquier estructura sin terminar puede ser dañada seriamente incluso por vientos ligeros.
- Versuchen Sie NICHT, Ihren Schuppen an einem windigen Tag aufzustellen. Die großen, flächigen Bauteile könnten wie ein Segel vom Wind erfasst und herumgeschleudert werden, was die Aufstellarbeiten erschwert und gefährlich macht.
- Do NOT attempt to assemble your building on a windy day. The large panels can catch the wind like a "sail", making construction difficult and unsafe. **Watch the Weather Closely**
- Ne PAS tenter d'assembler l'abri en présence de vent. Les grands panneaux peuvent se comporter comme une voile et « battre » au vent, rendant la construction difficile et dangereuse. **Suivre la météo avec attention**
- NO trate de montar la estructura en un día ventoso. Los paneles grandes pueden atrapar el viento como una "vela", lo que hace que sean llevados por el viento, lo que, a su vez, hace que la construcción sea difícil e insegura. **Observe el clima atentamente**
- Versuchen Sie NICHT, Ihren Schuppen zu montieren, bevor Sie sich nochmals vergewissert haben, dass Sie alle in der Teilleiste. Ein nur teilweise montiert zurückgelassener Schuppen kann bereits durch leichten Wind schwer beschädigt werden.
- Keep children and pets away from the worksite during construction and until the building is completely assembled. This will help avoid distractions and any accidents which may occur.
- Tenir les enfants et les animaux domestiques à l'écart du chantier durant la construction et jusqu'à ce que l'abri soit complètement assemblé. Cela évite les distractions et les accidents potentiels.
- No permita entrar a niños ni animales domésticos en el lugar de trabajo durante la construcción y hasta que la estructura esté completamente montada. Esto ayudará a evitar distracciones y cualquier accidente que pueda producirse.
- Halten Sie Kinder und Haustiere während der Montage und bis der Schuppen vollständig aufgestellt ist vom Aufstellplatz fern. Dies hilft, Ablenkungen und damit einhergehende Unfälle zu verhindern.
- NEVER concentrate your weight on the roof of the building.
- NE JAMAIS concentrer son propre poids sur le toit de l'abri.
- NUNCA concentre su peso en el techo de la estructura.
- Belasten Sie das Dach des Schuppens NIEMALS punktuell mit Ihrem Gewicht.
- Before assembling any parts, your base should be constructed and an anchoring system should be ready to use. Your building MUST be anchored to prevent wind damage.
- Avant de commencer à assembler des pièces, la base doit avoir été construite et le système d'ancrage doit être prêt à l'emploi. L'abri doit IMPÉRATIVEMENT être ancré pour éviter les dommages par le vent.
- Antes de montar cualquier pieza, debe estar construida la base y preparado el sistema de anclaje. La estructura DEBE estar anclada para evitar daños por vientos.
- Das Fundament sollte vor dem Zusammenbau der Teile gebaut und das Verankerungssystem nutzungsbereit sein. Ihr Schuppen MUSS verankert werden, um Schäden durch Wind zu verhindern.





- The best location is a level area with good drainage.
- Le meilleur emplacement sera une surface de niveau à bon drainage.
- El mejor lugar es un área nivelada con buen drenaje.
- Der bestmögliche Bauplatz ist eben mit einer guten Drainage.
- Allow enough space outside the building to be able to access the roof with a ladder.
- Laissez suffisamment d'espace à l'extérieur du bâtiment pour être en mesure d'accéder à la toiture avec une échelle.
- Deje suficiente espacio afuera del edificio para poder tener acceso al techo con una escalera.
- Es muß außerdem genügend Platz außerhalb des Gerätehauses vorgesehen werden, damit die Blechschrauben von außen aus verschraubt werden können.
- **Use Teamwork:** Two or more people are required to assemble your building.
- **Travailler en équipe:** Deux personnes ou plus sont nécessaires pour assembler l'abri.
- **Trabaje en equipo:** Se necesitan dos o más personas para ensamblar su cobertizo.
- **Arbeiten Sie im Team:** Mindestens zwei Personen werden für die Montage des Gerätehauses benötigt.

**CARE & MAINTENANCE / SOINS ET ENTRETIEN / PROTECCIÓN Y CONSERVACIÓN/
PFLEGE & INSTANDHALTUNG**

- DO NOT use power washing to clean your shed.
- NE PAS utiliser de jet sous haute pression pour nettoyer l'abri.
- NO utilice hidrolavadora para limpiar el cobertizo.
- Reinigen Sie Ihren Schuppen NICHT mit dem Hochdruckreiniger.
- Combustibles and corrosives must be stored in air tight containers designed for chemical and/or combustible storage. Corrosive chemicals such as fertilizers, pesticides and herbicides should be cleaned off the interior and exterior surfaces immediately. Rust caused by chemical damage is not covered by the warranty.
- Les matières combustibles et corrosives doivent être entreposées dans des contenants étanches à l'air conçus pour l'entreposage de produits chimique et/ou combustibles. Les produits chimiques corrosifs tels que les engrais, pesticides et herbicides doivent immédiatement être nettoyés des surfaces intérieures et extérieures. La rouille causée par des produits chimiques n'est pas couverte par la garantie.
- Los combustibles y productos corrosivos deben guardarse en contenedores herméticos diseñados para almacenamiento de químicos o combustibles. Se deben limpiar inmediatamente los químicos corrosivos, como fertilizantes, pesticidas y herbicidas, de las superficies interiores y exteriores. El óxido causado por daños químicos no está cubierto por la garantía.
- Brennbare und ätzende Stoffe müssen in luftdichten Behältern gelagert werden, die zur Lagerung von Chemikalien und/oder Brennstoffen vorgesehen sind. Ätzende Chemikalien wie z. B. Dünger, Insektenvernichter und Unkrautvernichter sollten sofort von den Innen- und Außenflächen abgewischt werden. Durch die Lagerung von Chemikalien entstandener Rost wird nicht von der Gewährleistung abgedeckt.

**Rust protection precautions / Des mesures de protection contre la rouille /
Las precauciones de protección contra el óxido/ Rostschutzmaßnahmen**

- Avoid nicking or scraping the coating surface, inside and out.
- Éviter d'entailler ou de rayer le revêtement de surface, à l'intérieur comme à l'extérieur.
- Evite dañar o raspar la capa protectora, por dentro y por fuera.
- Vermeiden Sie es, die Oberflächenbeschichtung an der Innen- und Außenseite zu beschädigen oder zu verkratzen.
- Keep roof, base perimeter and door free of debris.
- Nettoyer le toit, le pourtour de la base et les rails de porte de tous débris.
- Mantenga el techo, el perímetro de la base y los rieles de la puerta sin desechos.
- Halten Sie das Dach, den Bodenbereich und die Türführungen stets frei von Verunreinigungen.
- Touch up scrapes or nicks and any area of visible rust as soon as possible.
- Retoucher les entailles et égratignures et toute surface de rouille visible dès que possible.
- Retoque las raspaduras o las muescas y cualquier área de todo óxido visible lo más pronto posible.
- Bessern Sie Kratzer oder Beschädigungen und alle Bereiche mit sichtbarem Rost so schnell wie möglich aus.

Key No. Rep. N.º de referencia Lfd. Nr.	Part No. Réf. pièce N.º de pieza Art.-Nr.	Part Description	Description de la pièce	Descripción de la pieza	Bezeichnung	Qty. Qté Cant. Menge	Part Views Profils de pièces Vistas desde un extremo Vor-handen
1	65103	Hex Nut (#8-32)	Écrou hexagonal (8-32)	Tuerca hexagonal (N.º 8-32)	Sechskantmutter (#8-32)	102	
2	65923	Small Bolt (#8-32 x 3/8) (10 mm)	Petit boulon (8-32 x 3/8) (10 mm)	Perno pequeño color arena (N.º 8-32 x 3/8) (10 mm)	Kleine Maschinenschraube (#8-32 x 3/8) (10 mm)	102	
3	65004	Small Screw (#8AB x 5/16) (8 mm)	Petite vis (8AB x 5/16) (8 mm)	Tornillo pequeño color arena (N.º 8AB x 5/16) (8 mm)	Kleine Blechschraube (#8AB x 5/16) (8 mm)	280	
4	65900	Black Screw (#10B x 1/2) (13 mm)	Vis noire (#10B x 1/2) (13 mm)	Tornillo negro (#10B x 1/2) (13 mm)	Schwarze Schrauben (#10B x 1/2) (13 mm)	8	
5	65109	Acorn Nut (#8-32)	Écrou borgne (#8-32)	Tuerca cupulada (#8-32)	Hutmutter (#8-32)	6	

The fasteners used in each step are shown actual size at the top of each page. If you are unsure which fastener to use, hold it up to the picture and use the one that matches.

Les éléments de visserie utilisés à chaque étape sont représentés en taille réelle en haut de chaque page. En cas de doute sur le type de visserie à utiliser, les placer sur l'image et utiliser celui qui correspond.

Los tornillos y pernos que se utilizan en cada paso se muestran en el tamaño real en la parte superior de cada página. Si no está seguro de qué tornillo o perno de usar, compárelo con la imagen y use el que coincida con ella.







Die in den jeweiligen Schritten verwendeten Verbindungselemente werden am oberen Seitenrand jeweils in tatsächlicher Größe gezeigt. Falls Sie unsicher sind, welches Verbindungselement Sie verwenden sollen, dann halten Sie es vor das Bild und verwenden Sie dasjenige, das passt.

HARDWARE LIST

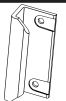
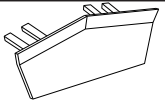
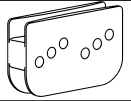
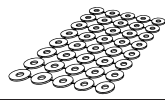
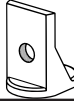
LISTE DE LA VISSERIE
LISTA DE PIEZAS

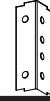
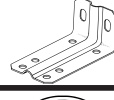
KLEINTEILELISTE









06HY

Key No. Rep. N.º de referencia Lfd. Nr.	Part No. Réf. pièce N.º de pieza Art.-Nr.	Part Description	Description de la pièce	Descripción de la pieza	Bezeichnung	Qty. Qté Cant. Menge	Part Views Profils de pièces Vistas desde un extremo Vor-handen
6	66045	Handle / Poignée de porte / Manija de la puerta / Türgriff				2	
7	67468	Peak Cap / Embout de faîte / Tope del caballete / Firstkappe				2	
8	66769	Door Slide / Coulisseau de porte / Rodamiento de la puerta / Türgleiter				4	
9	66646	Washer Sheet / Plaque de rondelles / Plancha de arandelas / Unterlegscheiben				8	
10	66382	Lower Door Guide / Guide de porte inférieure / Guía inferior de la puerta / Untere Türführung				4	
11	66183L	Left Roof Trim Cap / Embout de garniture de toit gauche / Tope del contramarco del techo izquierdo / Eckabschluß link				2	
12	66183R	Right Roof Trim Cap / Embout de garniture de toit droit / Tope del contramarco del techo derecho / Eckabschluß recht				2	
13	7916	Roof Beam Bracket / Attache de poutre de toit / Abrazadera de la viga del techo / Dachbalkenträger				4	
14	6228	Track Support / Support de rail / Soporte del riel / Stützwinkel				2	
15	67293	Weather Stripping / Ruban de calfeutrage / Burlete / Dichtungsband				1	
16	30028	Nameplate / Plaque signalétique / Placa de identificación / Typenschild				1	
17	66775	Plug (Door Jamb Color/Clear) / Bouchon (Couleur Jambage de porte/ Transparente) / Tapón (Color Jamba de la puerta/ Transparente) / Stopfen (Türpfosten Farbe / Klar)				2	
18	66775	Plug (Door Color) / Bouchon (Couleur de la porte) / Tapón (Color de la puerta) / Stopfen (Türfarbe)				2	

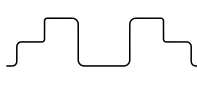
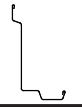
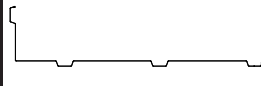
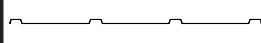
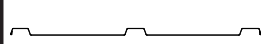
PARTS LIST

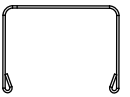
LISTE DES PIÈCES
ARTÍCULOS DE FERRETERÍA TEILELISTE



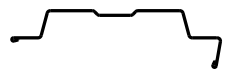



EN,FR,SP,GE-07HY

Key No. Rep. N.º de referencia Lfd. Nr.	Part No. Réf. pièce N.º de pieza Art.-Nr.	Part Description	Description de la pièce	Descripción de la pieza	Bezeichnung	Qty. Qté Cant. Menge	Part Views Profils de pièces Vistas desde un extremo Vor-handen
1	8946	Side Floor Frame	latéral Cadre de plancher	Tirante del entramado del piso lateral	Seitenbodenrahmen	2	
2	11481	Rear Floor Frame	Cadre de plancher arrière	Tirante del entramado trasero del piso	Bodenrahmen hinten	2	
3	8941	Ramp	Seuil	Rampa	Türschwelle	1	
4	9379	Front Floor Frame	Cadre de plancher avant	Tirante del entramado delantero del piso	Bodenrahmen vorne	2	
5	11475	Corner Panel	Panneau de coin	Panel esquinero	Eckblech	2	
6	11491	Front Corner Panel	Panneau de coin avant	Panel esquinero delantero	Eckblech vorne	2	
7	11472	Wall Panel	Panneau de mur	Panel de la pared	Wandblech	6	
8	11477	Wall Panel	Panneau de mur	Panel de la pared	Wandblech	2	
9	11484	Rear Wall Channel	Longeron de mur	Canaleta de la pared	Rückwand verstrebung	2	
10	9920	Side Wall Channel	Longeron de mur latéral	Canaleta de la pared lateral	Seitenrückwand verstrebung	2	
11	80245	Door Panel	Panneau porte	Panel puerta	Tür	2	
12	8476	Side Wall Angle	Cornière de mur latéral	Ángulo de la pared lateral	Seitenwandwinkel	3	
13	11486	Rear Wall Angle	Cornière arrière	Ángulo de la pared trasera	Rückwandwinkel	2	
14	11479	Door Jamb	Jambage de porte	Jamba de la puerta	Türpfosten	2	

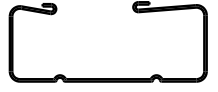
PARTS LIST

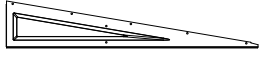
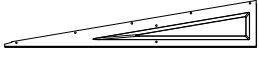
LISTE DES PIÈCES
ARTÍCULOS DE FERRETERÍA TEILELISTE

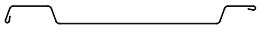

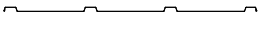
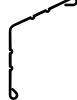
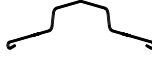
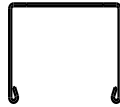
EN,FR,SP,GE-08HY

Key No. Rep. N.º de referencia Lfd. Nr.	Part No. Réf. pièce N.º de pieza Art.-Nr.	Part Description	Description de la pièce	Descripción de la pieza	Bezeichnung	Qty. Qté Cant. Menge	Part Views Profils de pièces Vistas desde un extremo Vor-handen
15	6617	Door Track Splice / Raccord de rail de porte / Empalme del riel de la puerta / Türschienenlasche				1	
16	9378	Door Track / Rail de porte / Riel de la puerta / Türlaufschiene				2	
17	6658	Gable Brace / Renfort de pignon / Abrazadera del gablete / Giebelverstärkung				2	
18	7906	Right Gable / Pignon droit / Gablete derecho / Giebel rechts				2	
19	7907	Left Gable / Pignon gauche / Gablete izquierdo / Giebel links				2	
20	8474	Roof Beam / Poutre de toit / Viga del techo / Dachträger				3	
21	8466	Right Roof Panel / Panneau de toit droit / Panel del techo derecho / Dachblech rechts				2	
22	8467	Left Roof Panel / Panneau de toit gauche / Panel del techo izquierdo / Dachblech links				2	
23	7875	Roof Panel / Panneau de toit / Panel del techo / Dachblech				4	
24	8482	Roof Trim / Garniture de toit / Contramarco del techo / Dachabschlussleiste				2	
25	8461	Ridge Cap / Faîtage / Tope del caballete / Firstabdeckung				1	
26	11480	Vertical Door Channel / Canal d'ouverture verticale de la porte / Canal de puerta vertical / Vertikale Türschiene				2	

PARTS LIST

LISTE DES PIÈCES
ARTÍCULOS DE FERRETERÍA TEILELISTE

EN,FR,SP,GE-09HY

Key No. Rep. N.º de referencia Lfd. Nr.	Part No. Réf. pièce N.º de pieza Art.-Nr.	Part Description	Description de la pièce	Descripción de la pieza	Bezeichnung	Qty. Qté Cant. Menge	Part Views Profils de pièces Vistas desde un extremo Vor-handen
27	10498	Horizontal Door Brace / Renfort d'ouverture horizontale de la porte / Abrazadera de puerta horizontal / Horizontale Türschiene				4	
28	69836	Edge Trim(Purple) / Garniture de bordure (violet) / Contramarco del gablete de (morada) / Kantenschutz (Lila)				4	

ASSEMBLY BY KEY NO.

PIÈCES PAR N° DE REPÈRE MONTAGE NACH LFD. NR.
MONTAJE POR N.º DE REFERENCIA

10HY

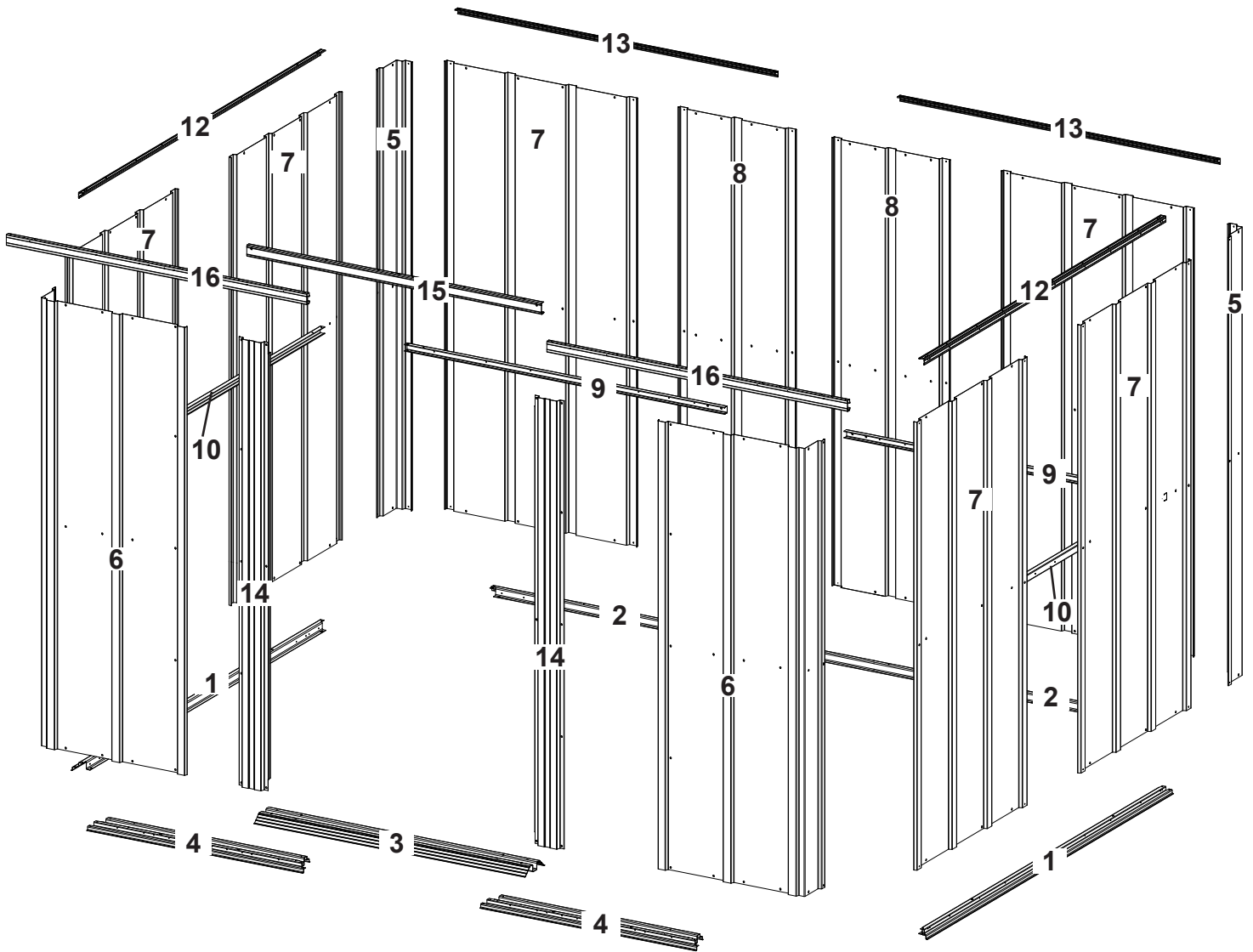

ASSEMBLY BY KEY NO.

PIÈCES PAR N° DE REPÈRE MONTAGE NACH LFD. NR.
MONTAJE POR N.º DE REFERENCIA

11HY

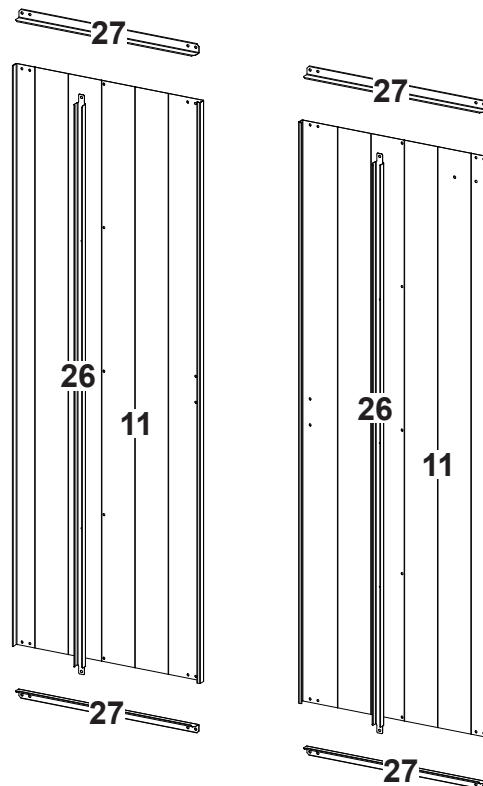
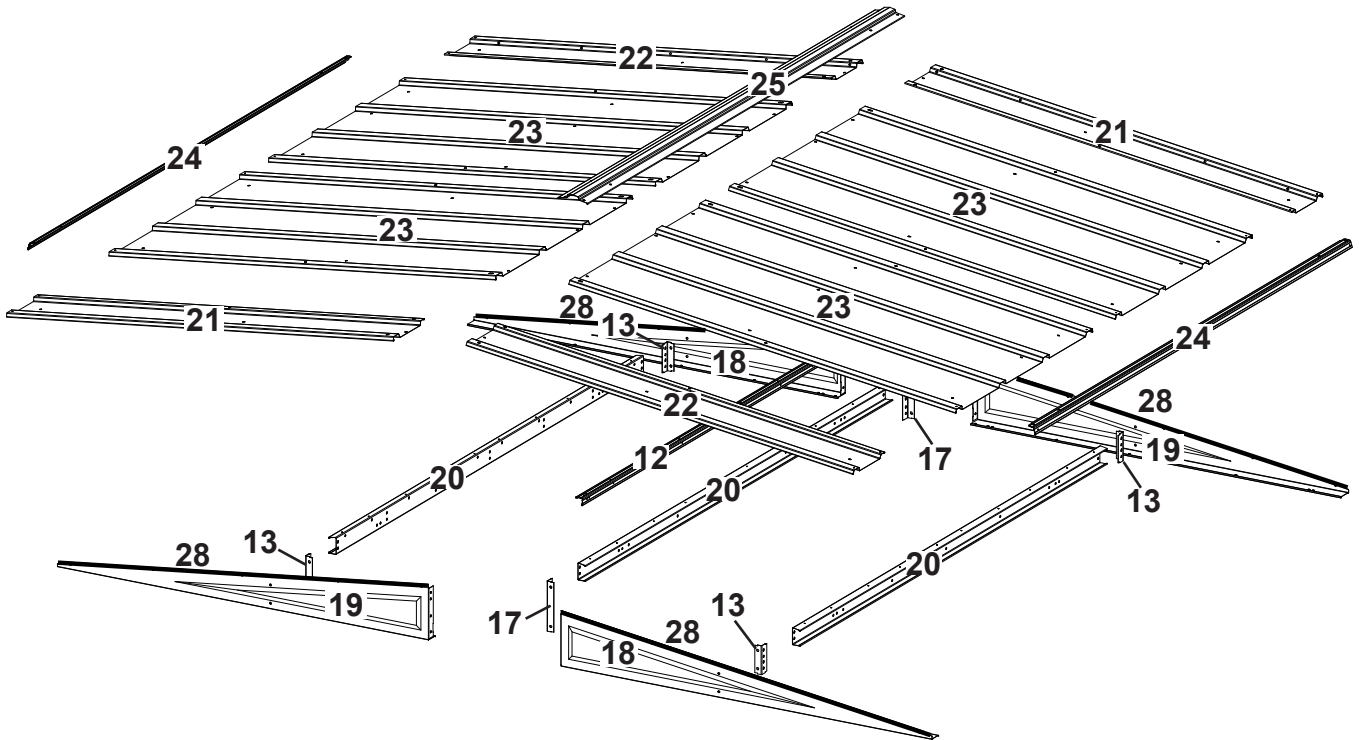

Wood Platform / Plateforme en bois

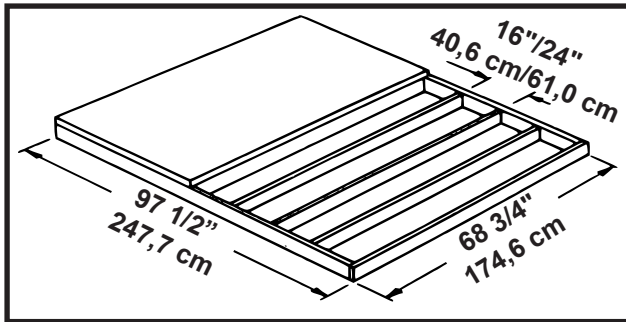

Concrete Slab / Dalle en béton

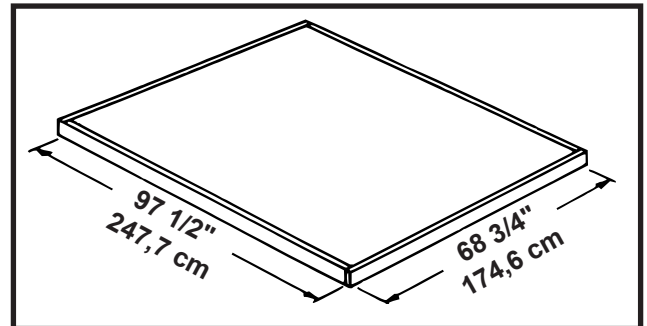

* IMPORTANT *

The base **MUST** be flat and level to provide adequate support for your building, otherwise the **PRE-DRILLED HOLES WILL NOT ALIGN AND IT CANNOT BE ASSEMBLED**. No matter which of the options below you choose for a base, an **ARROW ANCHORING KIT** is recommended as an effective method of properly securing your building after assembly is complete.

OPTION 1: Build directly on the ground

OPTION 2: Wood Platform

NOTE: Pressure Treated Lumber must **NOT** be used where it will make contact with your storage building. The properties of Pressure Treated Lumber will cause accelerated corrosion. **If Pressure Treated Lumber comes in contact with your storage building your warranty will be voided.** The platform should be level and flat (free of bumps, ridges, etc.) to provide good support for the building. The necessary materials may be obtained from your local lumber yard.

OPTION 3: Concrete Slab

The slab should be at least 4" (10,2 cm) thick.

* IMPORTANT *

La base **DOIT** être plate et de niveau pour fournir un support adéquat à votre bâtiment, sinon les trous **PRÉ-PERCÉS NE S'ALIGNERONT PAS ET ILS NE POURRONT PAS ÊTRE ASSEMBLÉS**. Quelque que soit l'option ci-dessous choisie pour la base, un **NÉCESSAIRE D'ANCRAGE ARROW** est recommandé pour amarrer solidement l'abri une fois que le montage est terminé.

OPTION 1 : Construire à même le sol

OPTION 2 : Plateforme en bois

REMARQUE : Ne **PAS** utiliser de bois traité sous pression aux points de contact avec l'abri. **Le bois traité sous pression contribue à accélérer la corrosion. Le contact de bois traité sous pression avec l'abri aura pour effet d'annuler la garantie.** La plateforme doit être plate et de niveau (sans bosses, arêtes, etc.) afin d'offrir un bon support à l'abri. Les matériaux nécessaires peuvent s'obtenir auprès d'un fournisseur de bois d'œuvre local.

OPTION 3 : Dalle en béton

La dalle doit avoir au moins 4 "(10,2 cm) d'épaisseur.

Plataforma de Madera / Plattform aus Holz

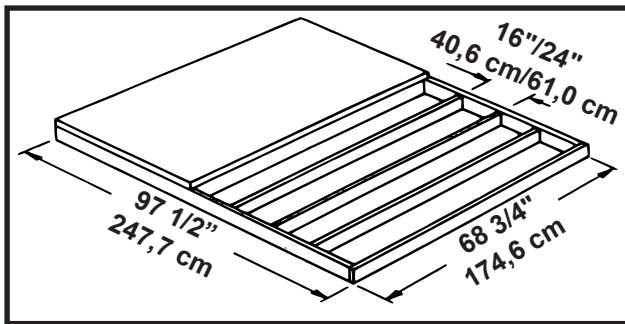

Losa de Hormigón / Bodenplatte aus Beton

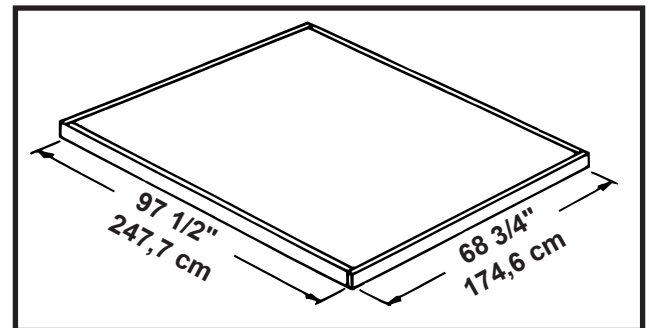

* IMPORTANTE *

La base **DEBE** ser plana y nivelada para proporcionar el soporte adecuado para su edificio; de lo contrario, los **AGUJEROS PRETALADRADOS NO SE ALINEARÁN Y NO SE PUEDEN MONTAR**. Independientemente de las siguientes opciones que elija como base, se recomienda un KIT DE SUJECIÓN ARROW como método eficaz para sujetar adecuadamente su cobertizo después de terminar el ensamblaje.

OPCIÓN 1: Construir directamente en el suelo

OPCIÓN 2: Plataforma de madera

NOTA: La madera tratada a presión **NO** debe usarse donde haga contacto con su edificio de almacenamiento. Las propiedades de la madera tratada a presión causarán corrosión acelerada. **Si la madera tratada a presión entra en contacto con su edificio de almacenamiento, su garantía quedará anulada.** La plataforma debe estar nivelada y plana (libre de golpes, crestas, etc.) para proporcionar un buen soporte para el edificio. Los materiales necesarios se pueden obtener de su aserradero local.

OPCIÓN 3: Losa de hormigón

La losa debe tener **al menos 4" (10,2 cm)** de espesor.

WICHTIG

Der Sockel **MUSS** flach und eben sein, um eine angemessene Unterstützung für Ihr Gebäude zu gewährleisten. Andernfalls werden die **VORGEBOHRTEN LÖCHER NICHT AUSGERICHTET UND ES KANN NICHT ZUSAMMENGEBAUT WERDEN**. Unabhängig davon, für welche der nachfolgend genannten Möglichkeiten Sie sich als Fundament entscheiden, empfiehlt sich ein ARROW-VERANKERUNGSKIT als wirkungsvolle Methode zur ordnungsgemäßen Sicherung Ihres Bauwerks nach Abschluss der Montagearbeiten.

MÖGLICHKEIT 1: Direkt auf dem Untergrund (Erde)

MÖGLICHKEIT 2: Plattform aus Holz

HINWEIS: An Stellen, an denen es mit Ihrem Geräteschuppen in Kontakt kommen würde, darf **kein** kesseldruckimprägniertes Holz verwendet werden. Kesseldruckimprägniertes Holz hat Eigenschaften, die zu beschleunigter Korrosion führen. **Wenn kesseldruckimprägniertes Holz mit Ihrem Geräteschuppen in Kontakt kommt, wird Ihre Garantie ungültig.**

MÖGLICHKEIT 3: Bodenplatte aus Beton

Die Bodenplatte sollte **wenigstens 10,2 cm** stark sein.

1: FLOOR FRAME

CADRE DE PLANCHER
MARCO DE PISO

BODENRAHMEN

14HY

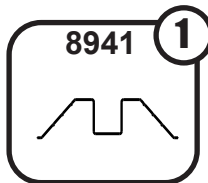
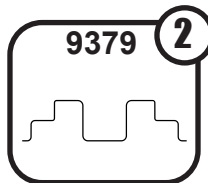
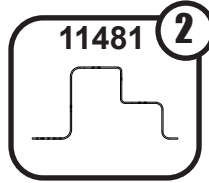
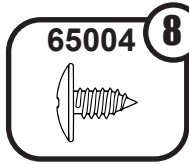
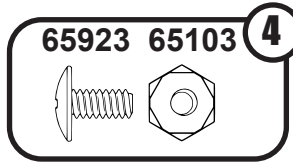

Overlap Length
Longueur de
chevauchement
Longitud de
superposición
Überlappung
11 7/8" 30,2 cm

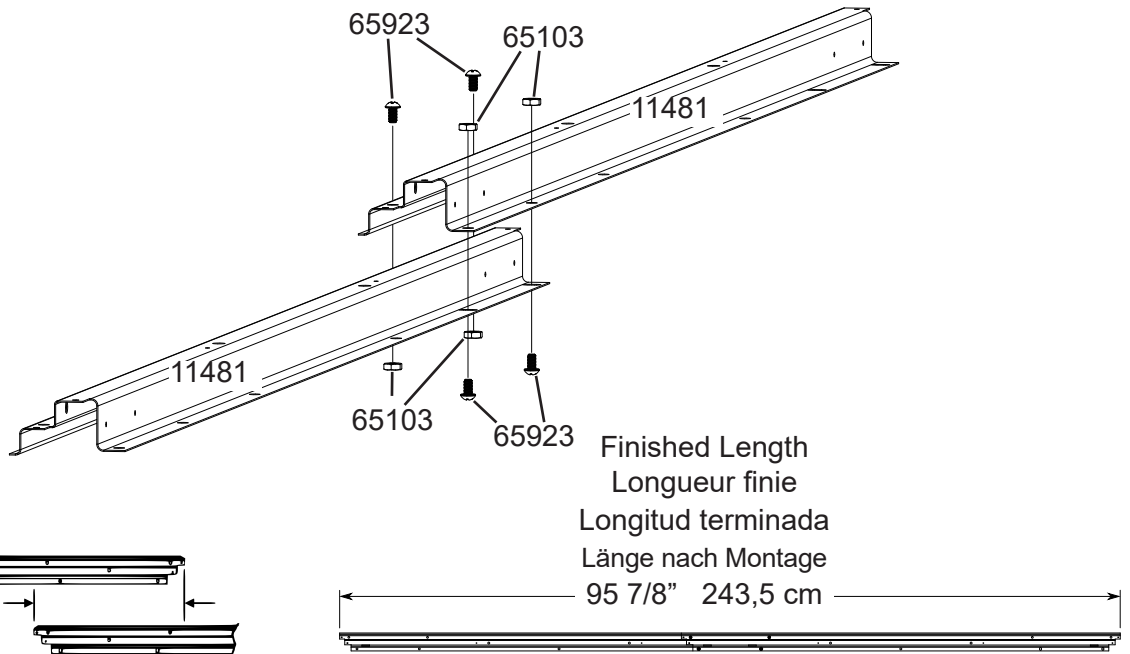
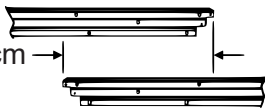

Finished Length
Longueur finie
Longitud terminada
Länge nach Montage
95 7/8" 243,5 cm

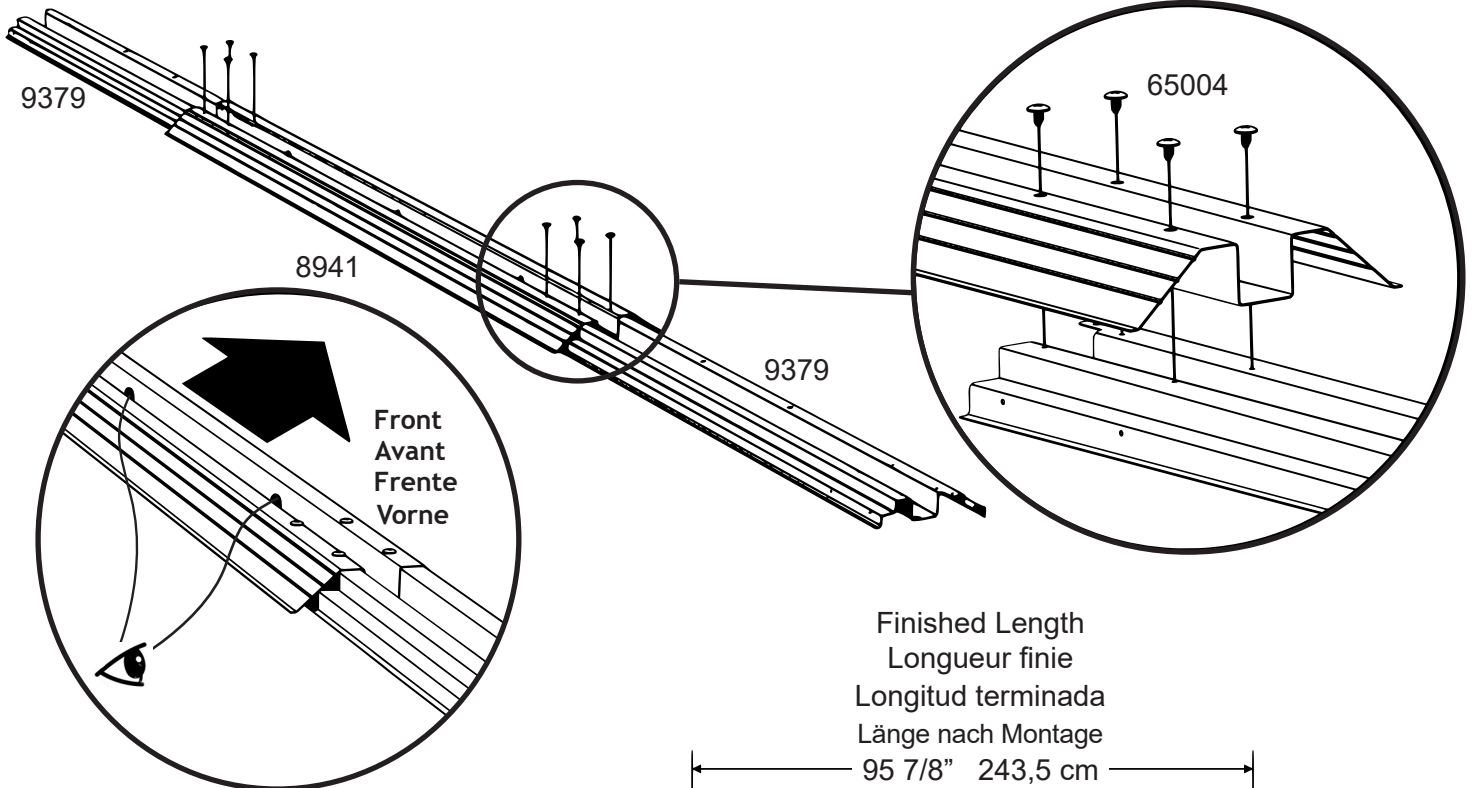

Finished Length
Longueur finie
Longitud terminada
Länge nach Montage
95 7/8" 243,5 cm

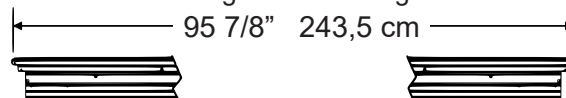

1: FLOOR FRAME

CADRE DE PLANCHER
MARCO DE PISO BODENRAHMEN

15HY

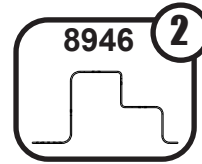
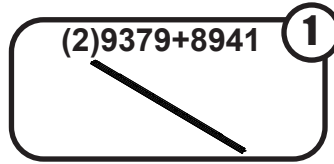
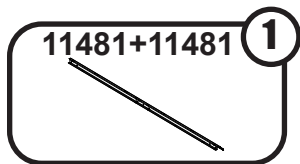
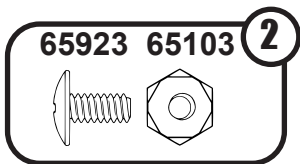
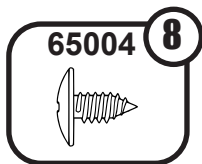

NOTES:

Do NOT fasten your Floor Frames to your Base at this time. You will anchor your building after it is erected.

The Floor Frame must be BOTH square AND level or the holes will not line up properly.

Measure diagonally from corner to corner. When diagonal measurements are equal, the Frame is square.

REMARQUES:

Ne PAS attacher les éléments de cadre de plancher à la base à ce stade. L'abri sera ancré une fois qu'il est assemblé.

Le cadre de plancher doit être À LA FOIS d'équerre et de niveau pour que les trous s'alignent correctement.

Mesurer en diagonale d'un coin à l'autre. Lorsqu'elles sont égales, le cadre de plancher est d'équerre.

NOTAS:

NO fije los tirantes del piso a la base en este momento. Anclará la estructura después de que esté erguida.

El tirante del piso debe estar TANTO cuadrado COMO nivelado o los orificios no se alinearán correctamente.

Mida diagonalmente de esquina a esquina. Cuando las medidas diagonales son iguales, el tirante está cuadrado.

HINWEIS:

Befestigen Sie Ihre Bodenrahmen noch NICHT am Fundament. Sie verankern Ihr Bauwerk erst, nachdem es fertig aufgebaut ist.

Der Bodenrahmen muss SOWOHL rechtwinklig ALS AUCH waagrecht sein. Andernfalls fluchten die Löcher nicht richtig.

Messen Sie diagonal von Ecke zu Ecke. Wenn die diagonalen Abmessungen gleich sind, ist der Rahmen rechtwinklig.

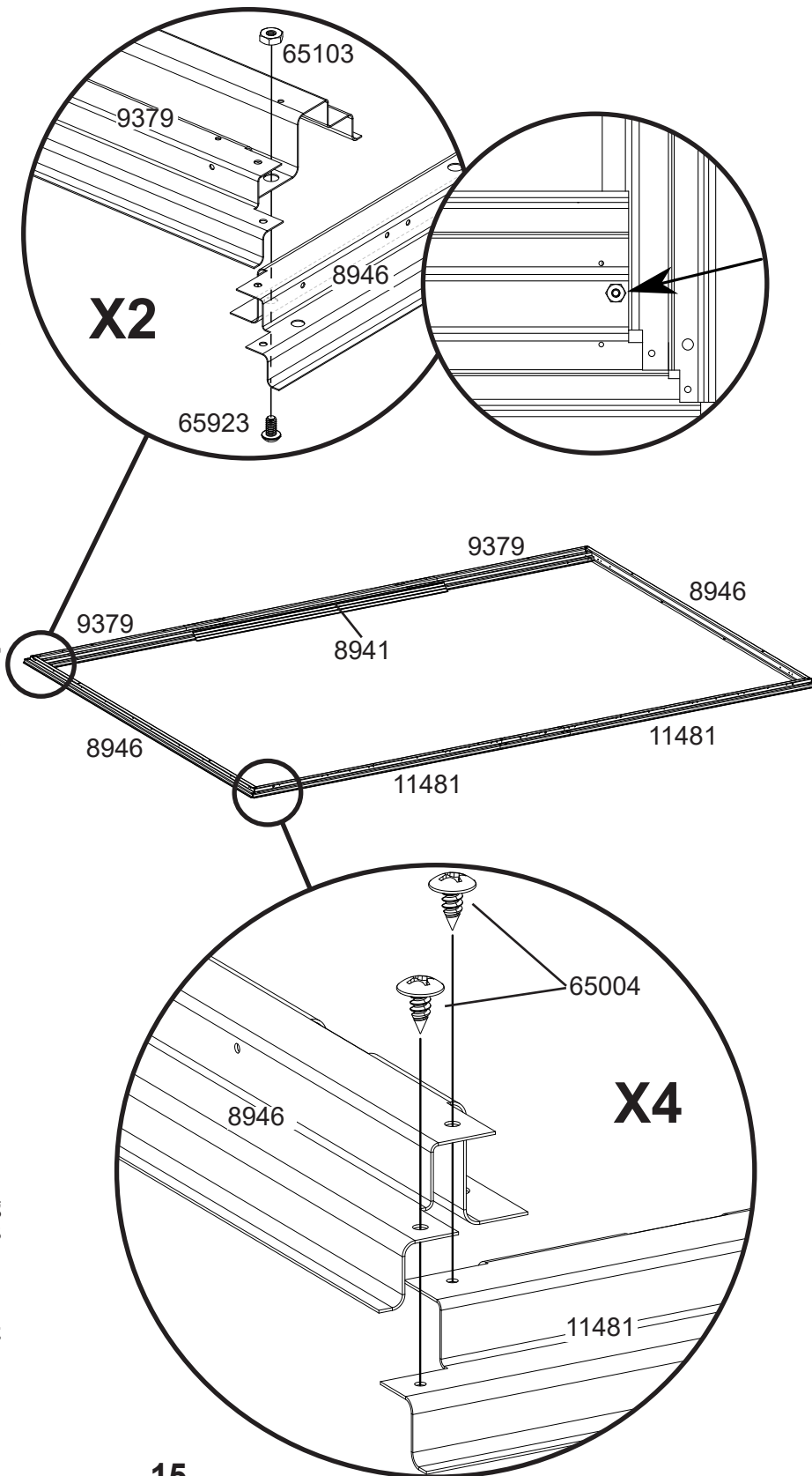

2: PRE-ASSEMBLY

PRÉ-ASSEMBLAGE
PRE-ENSAMBLE VORMONTAGE

16HY

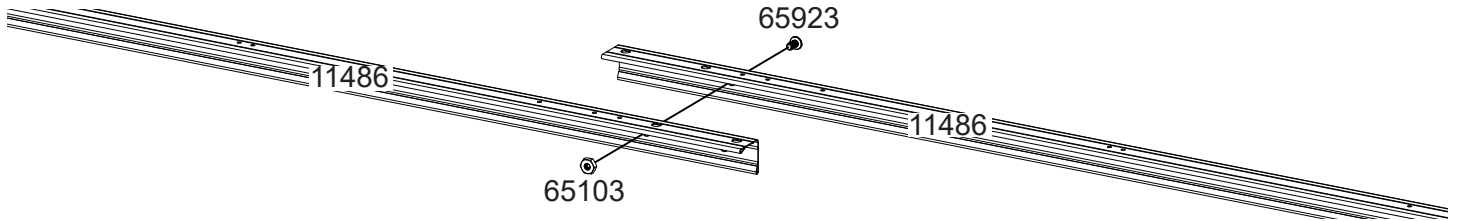
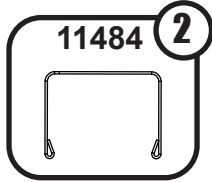
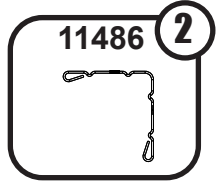
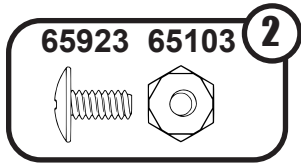

94 5/8" (240,3 cm)
Finished Length
Longueur finie
Longitud terminada
Länge nach Montage

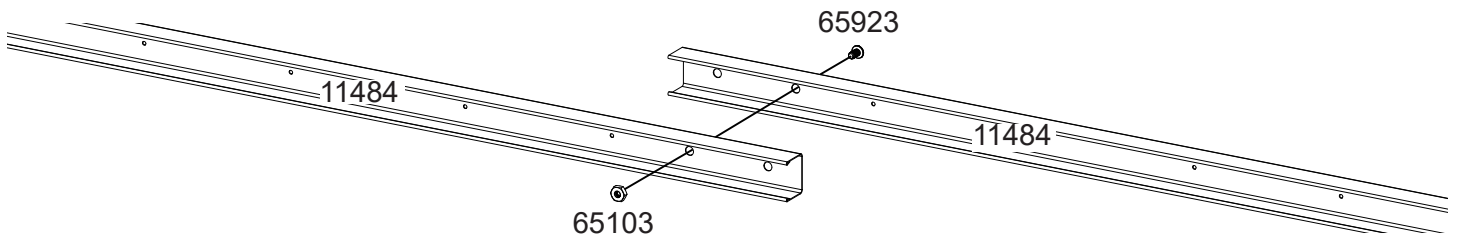

94 5/8" (240,3 cm)
Finished Length
Longueur finie
Longitud terminada
Länge nach Montage

2: PRE-ASSEMBLY

PRÉ-ASSEMBLAGE
PRE-ENSAMBLE VORMONTAGE

17HY

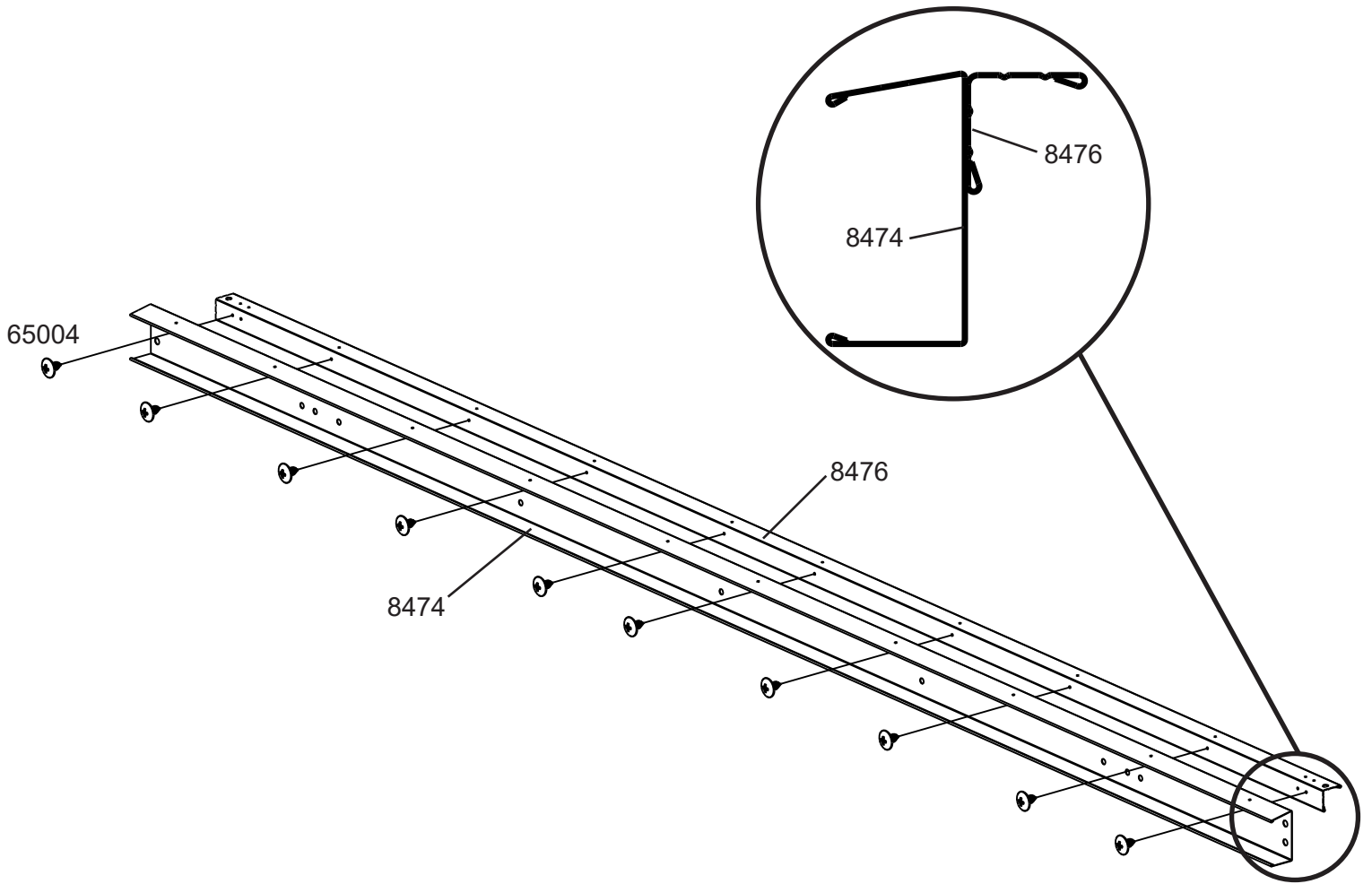
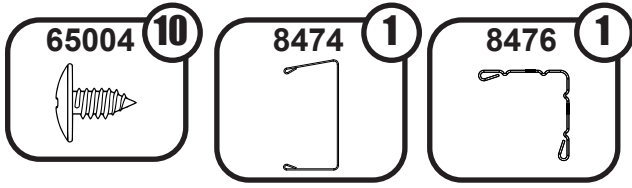

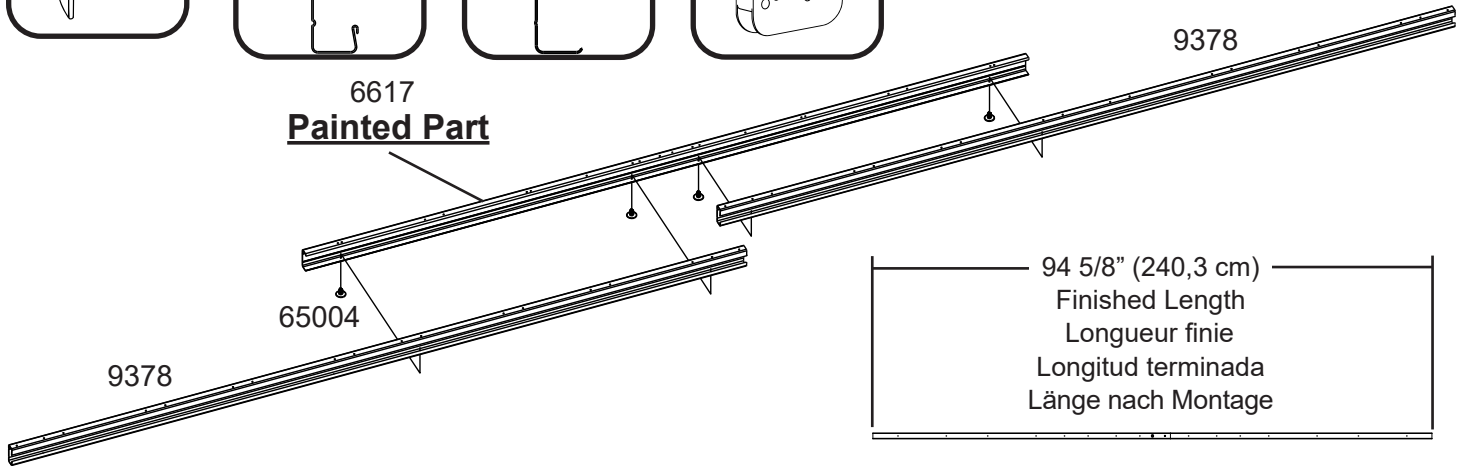
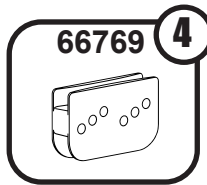
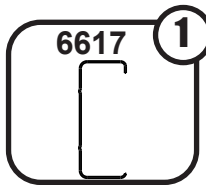
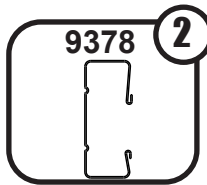
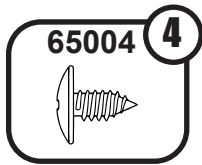

94 5/8" (240,3 cm)
Finished Length
Longueur finie
Longitud terminada
Länge nach Montage

END VIEW
PROFIL
VISTA DESDE UN EXTREMO
ENDANSICHT

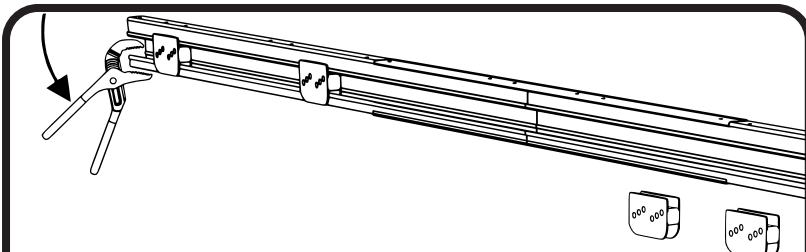
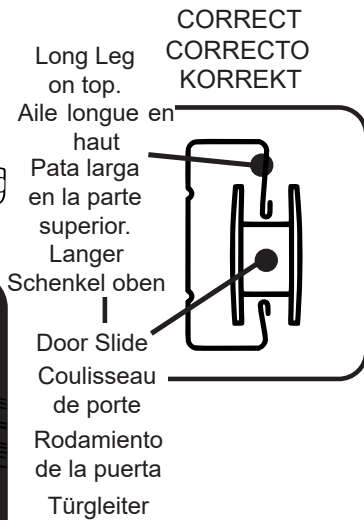
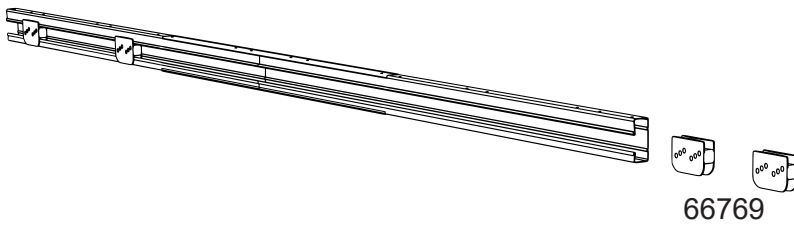

Slides should be installed in Door Track prior to installation. However, if this step is overlooked or if the Slides need to be removed for maintenance, the following procedure may be used.

Les coulisseaux doivent être placés dans le rail de porte avant la pose du rail. Toutefois, si cette étape est omise ou si les coulisseaux doivent être déposés à des fins d'entretien, la méthode suivante peut être utilisée.

Se deben instalar los rodamientos en el riel de la puerta antes de la instalación. Sin embargo, si se saltea este paso o si se deben extraer los rodamientos para mantenimiento, se debe realizar el siguiente procedimiento.

Die Schlitten sollten vor dem Einbau in der Türschiene montiert werden. Falls dieser Schritt ausgelassen wird oder die Schlitten für Wartungsarbeiten entfernt werden müssen, geht man wie folgt vor.

To remove or install Door Slides:

- Remove Doors from Slides and set aside.
- Using pliers, bend down a corner of the Door Track.
- Remove or install Door Slides.
- Carefully bend the corner back into position.

Pour déposer ou poser les coulisseaux de porte :

- Détacher les portes des coulisseaux et les mettre de côté.
- Avec une pince, rabattre un coin du rail de porte.
- Retirer ou enfiler les coulisseaux de porte.
- Avec précaution, remettre le coin du rail dans sa position d'origine.

Para extraer o instalar los rodamientos de la puerta:

- Saque las puertas de los rodamientos y sepárelas.
- Con un alicate, doble hacia abajo un ángulo del riel de la puerta.
- Saque o instale los rodamientos de la puerta.
- Con cuidado, doble el ángulo nuevamente a su posición.

Türschlitten Entfernen oder Einbauen:

- Türe der Schlitten entfernen und beiseite stellen.
- Mit einer Zange eine Ecke der Türschiene nach unten biegen.
- Türschlitten entfernen oder einbauen.
- Die Ecke vorsichtig zurück an ihren Platz biegen.

3: CORNER PANELS

PANNEAUX D'ANGLE
PANELES DE ESQUINA ECKPLATTEN

19HY

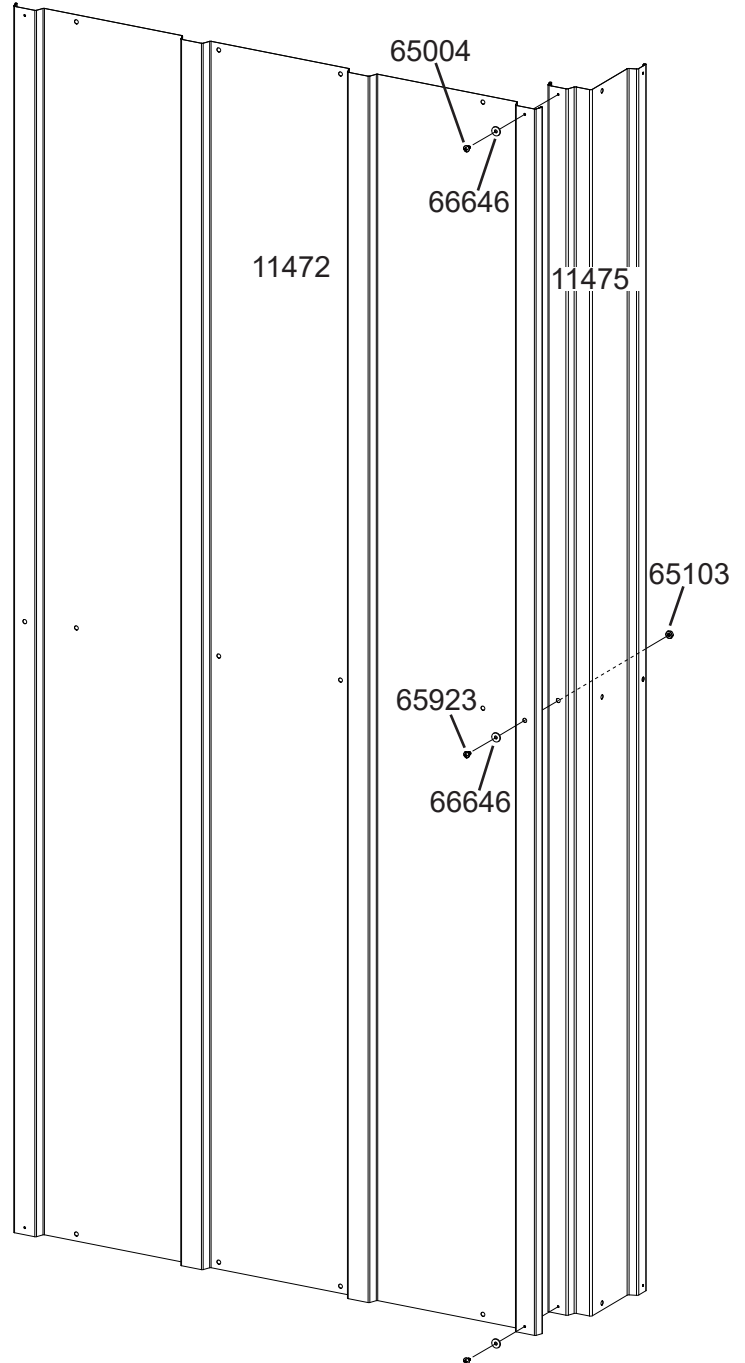
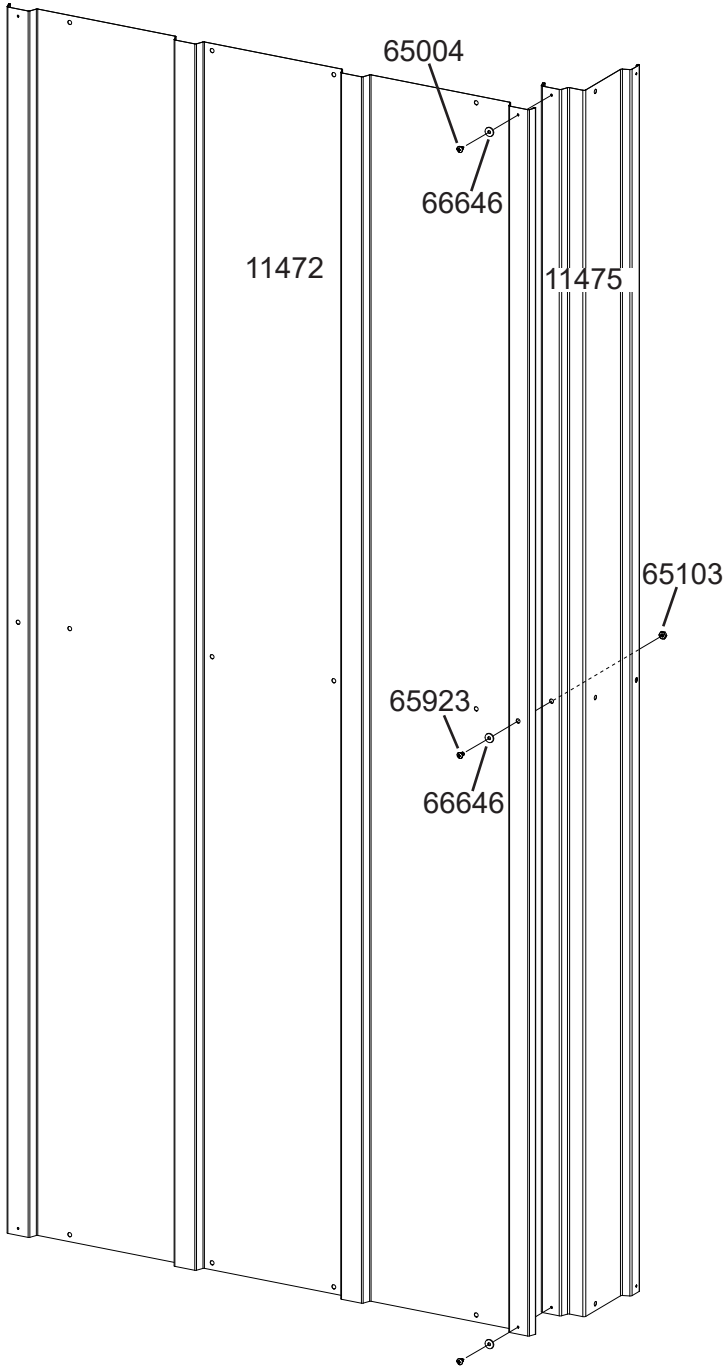
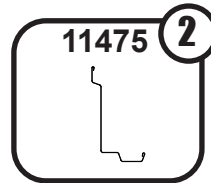
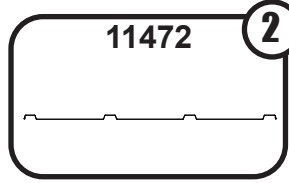
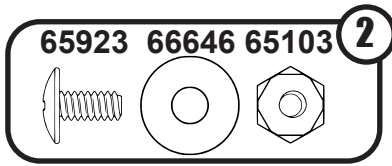
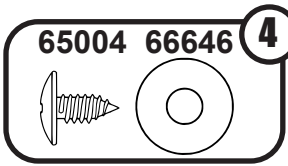

3: CORNER PANELS

PANNEAUX D'ANGLE
PANELES DE ESQUINA ECKPLATTEN

20HY

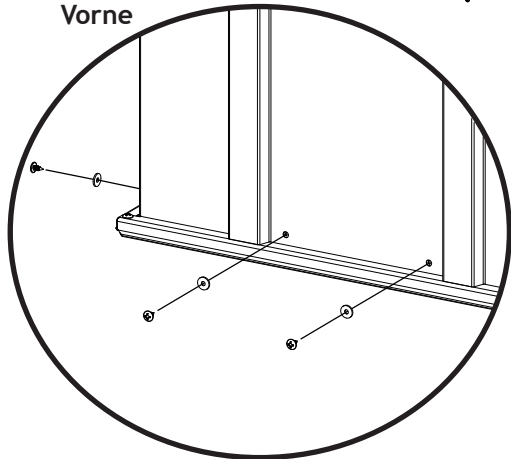
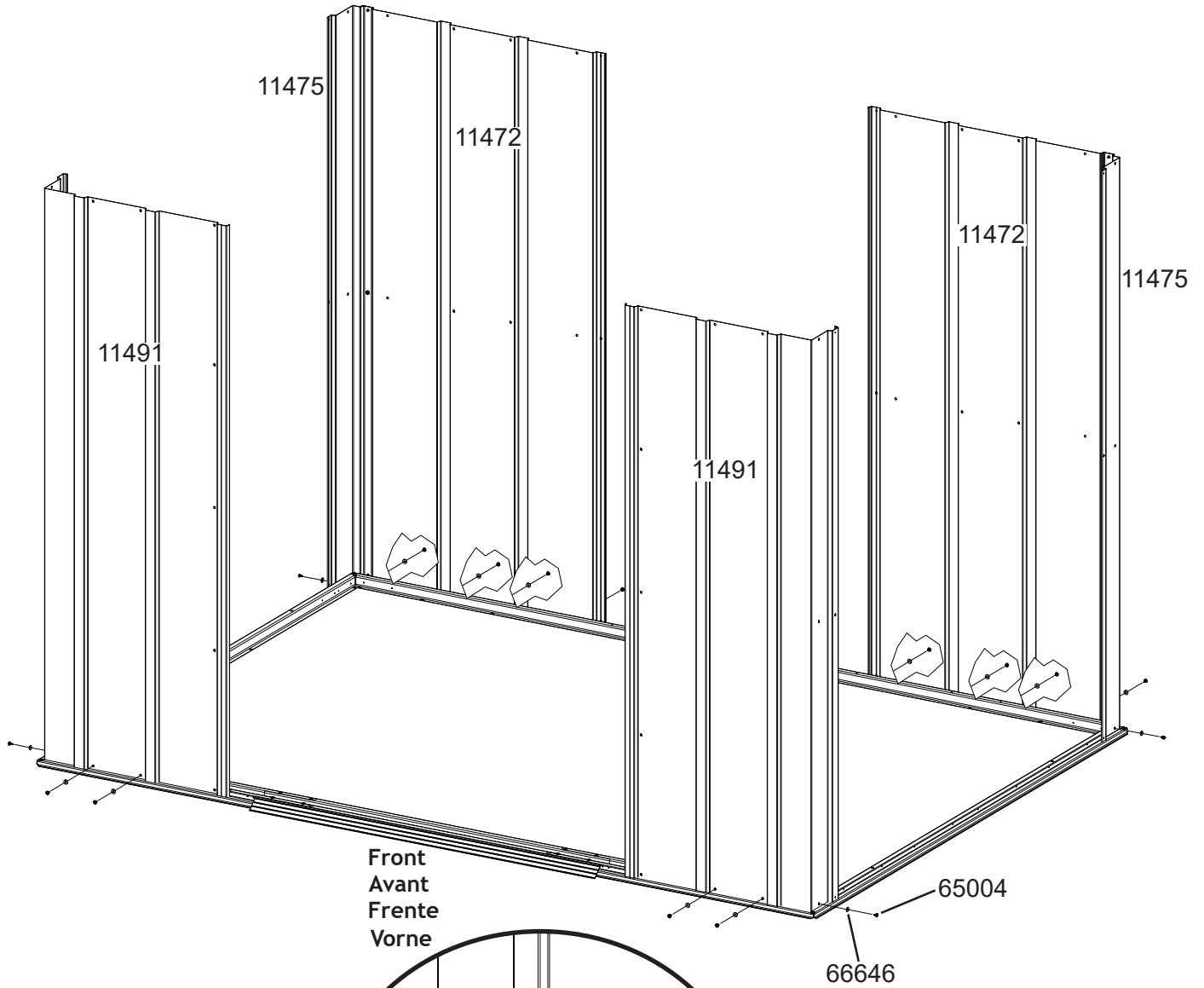
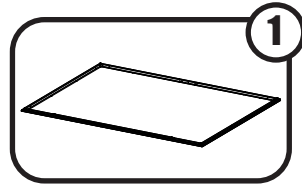
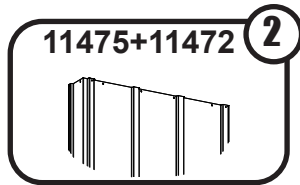
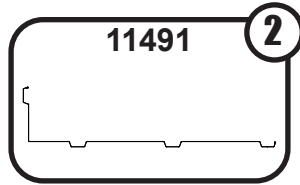
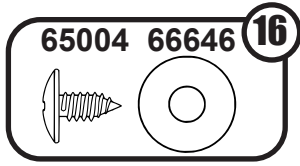

4: WALL ANGLE

CORNIÈRE DE MUR
 ÁNGULO DE LA PARED WANDWINKEL

21HY

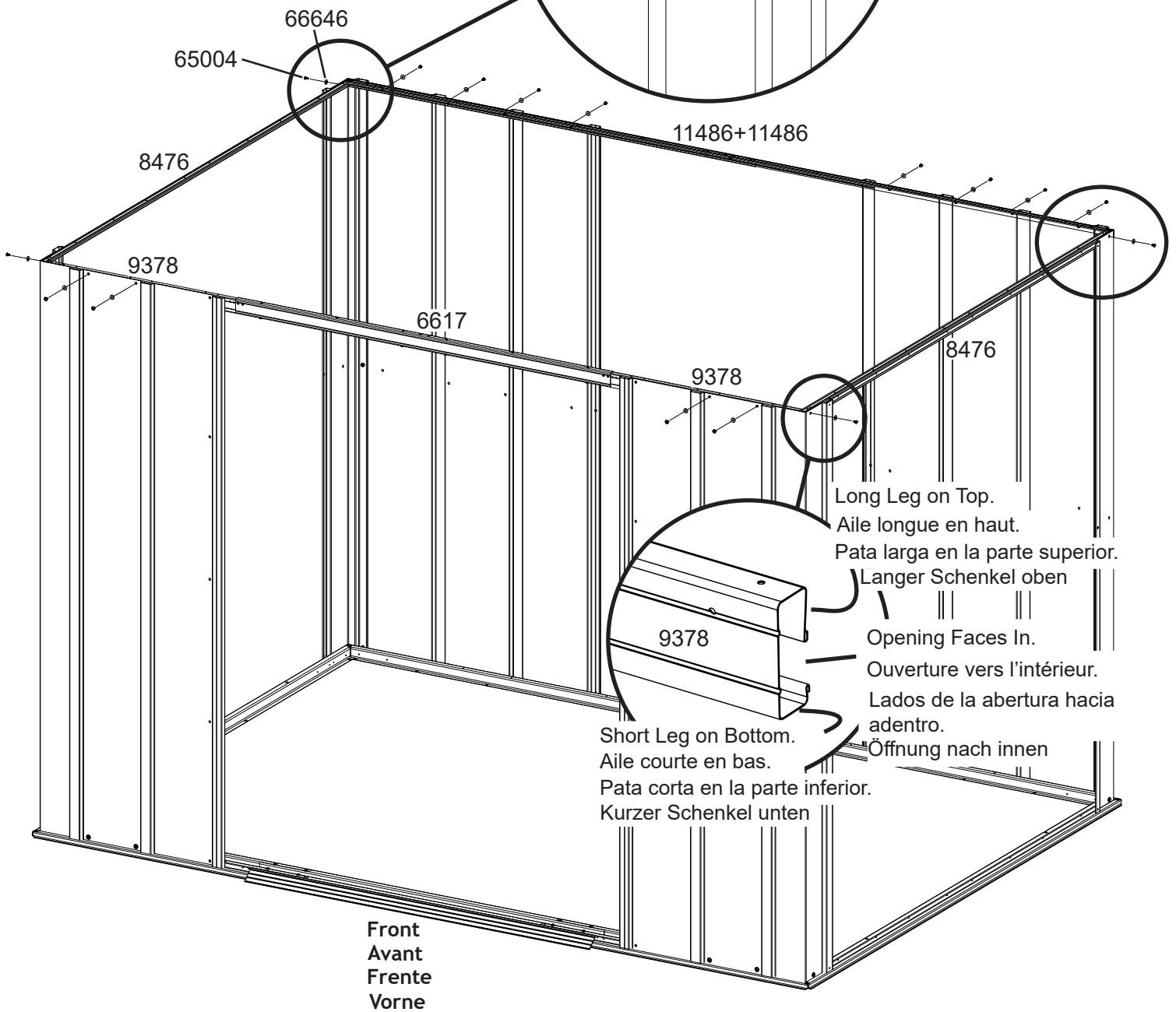
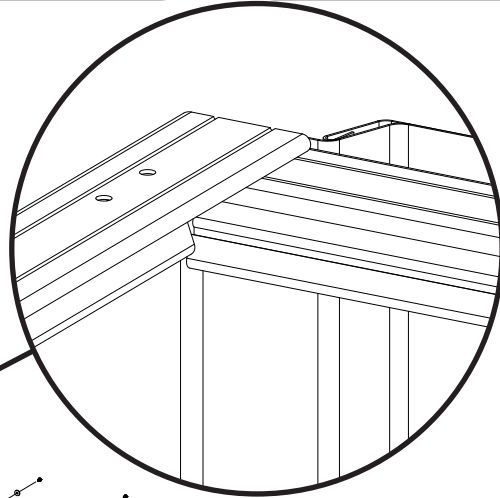
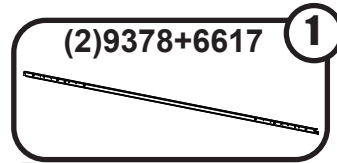
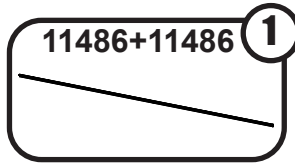
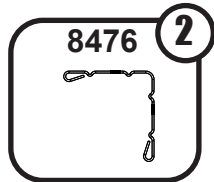
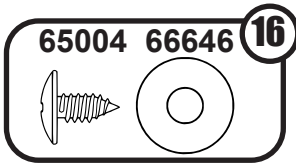

Long Leg on Top.
 Aile longue en haut.
 Pata larga en la parte superior.
 Langer Schenkel oben

Opening Faces In.
 Ouverture vers l'intérieur.
 Lados de la abertura hacia adentro.
 Öffnung nach innen

Short Leg on Bottom.
 Aile courte en bas.
 Pata corta en la parte inferior.
 Kurzer Schenkel unten

Front
 Avant
 Frente
 Vorne

5: WALL PANELS

PANNEAUX DE MUR
 PANELES DE LA PARED WANDBLECHE

22HY

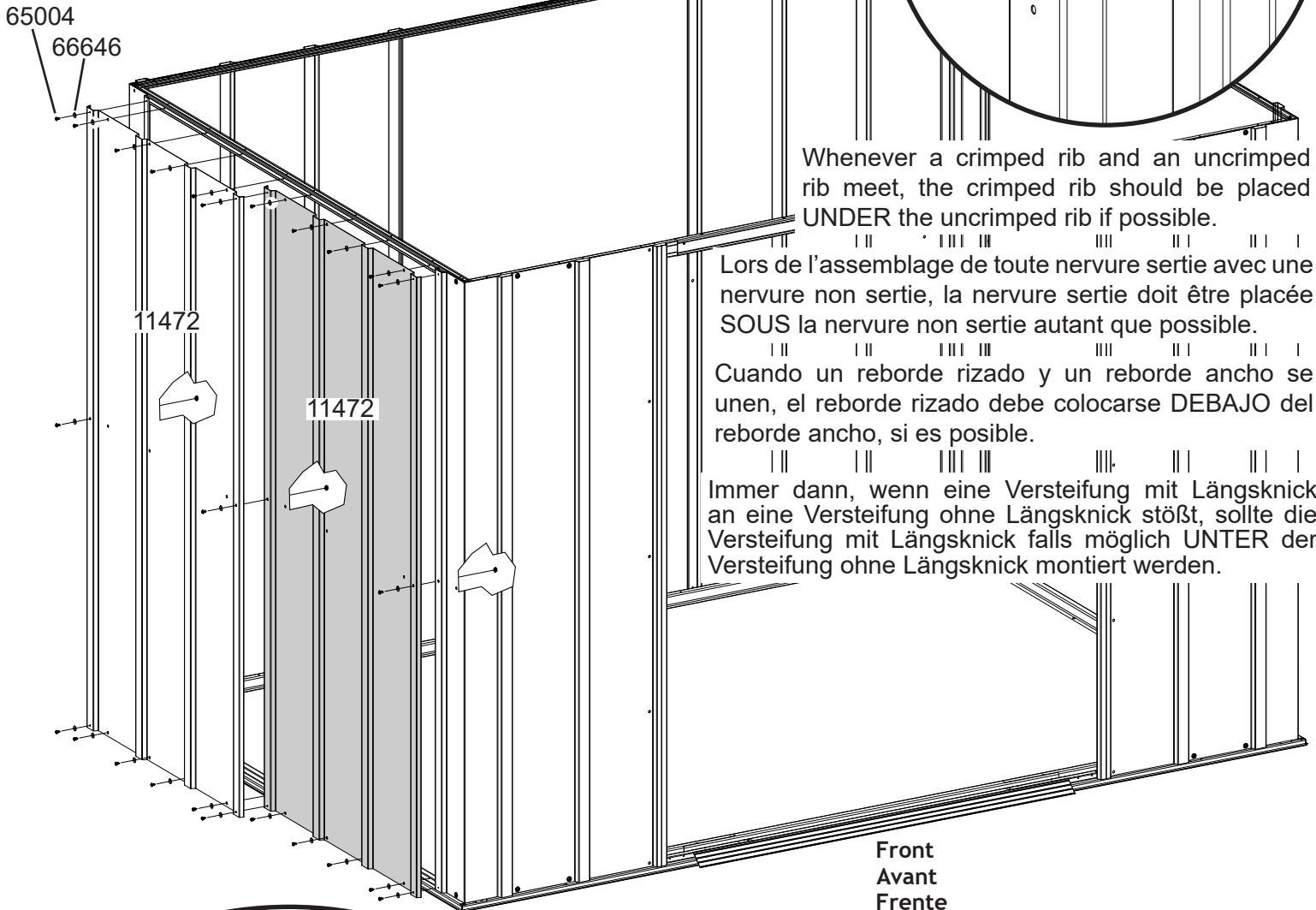
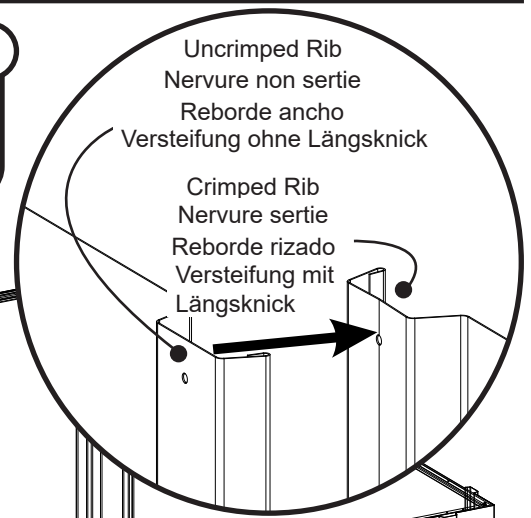
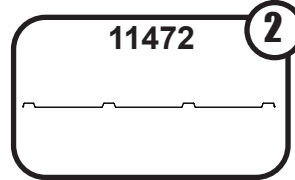
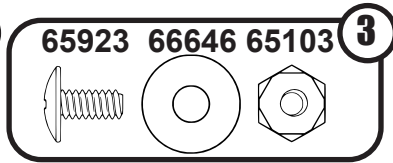
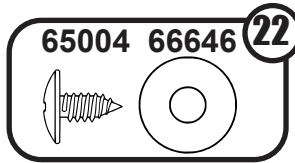

Whenever a crimped rib and an uncrimped rib meet, the crimped rib should be placed **UNDER** the uncrimped rib if possible.

Lors de l'assemblage de toute nervure sertie avec une nervure non sertie, la nervure sertie doit être placée **SOUS** la nervure non sertie autant que possible.

Cuando un reborde rizado y un reborde ancho se unen, el reborde rizado debe colocarse **DEBAJO** del reborde ancho, si es posible.

Immer dann, wenn eine Versteifung mit Längsknick an eine Versteifung ohne Längsknick stößt, sollte die Versteifung mit Längsknick falls möglich **UNTER** der Versteifung ohne Längsknick montiert werden.

Front
 Avant
 Frente
 Vorne

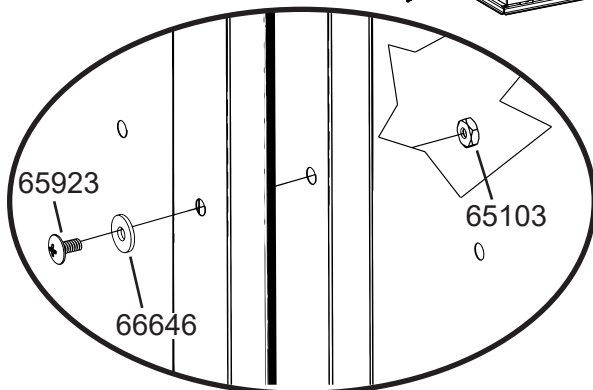

5: WALL PANELS

PANNEAUX DE MUR
PANELES DE LA PARED WANDBLECHE

23HY

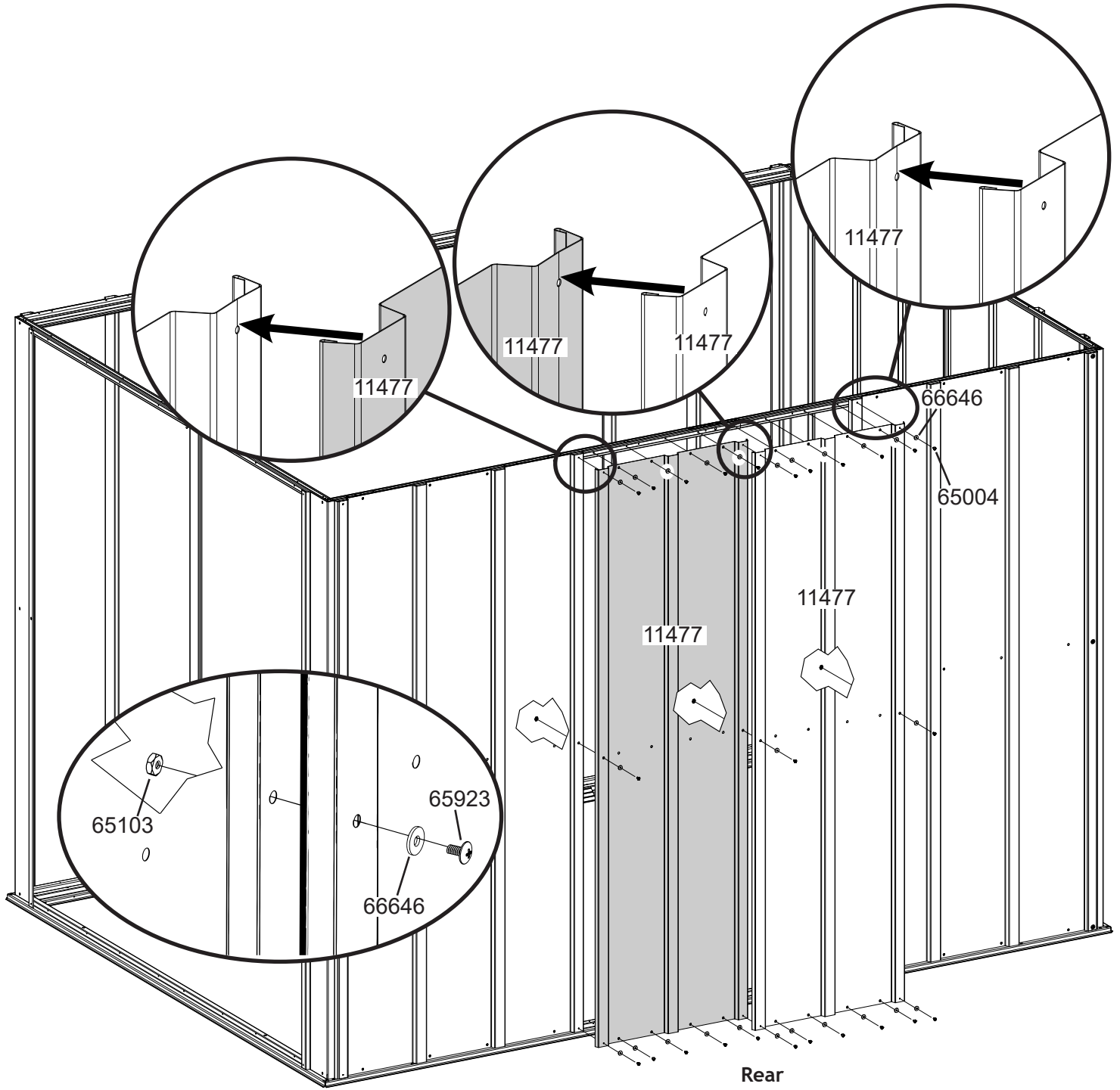
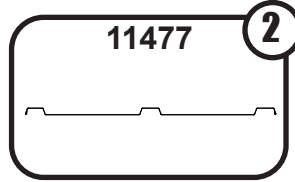
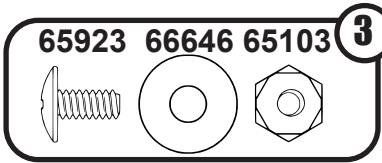
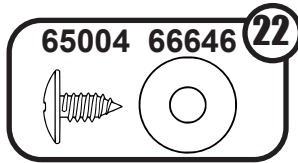

Rear
Arrière
Atrás
Hinten

5: WALL PANELS

PANNEAUX DE MUR
PANELES DE LA PARED WANDBLECHE

24HY

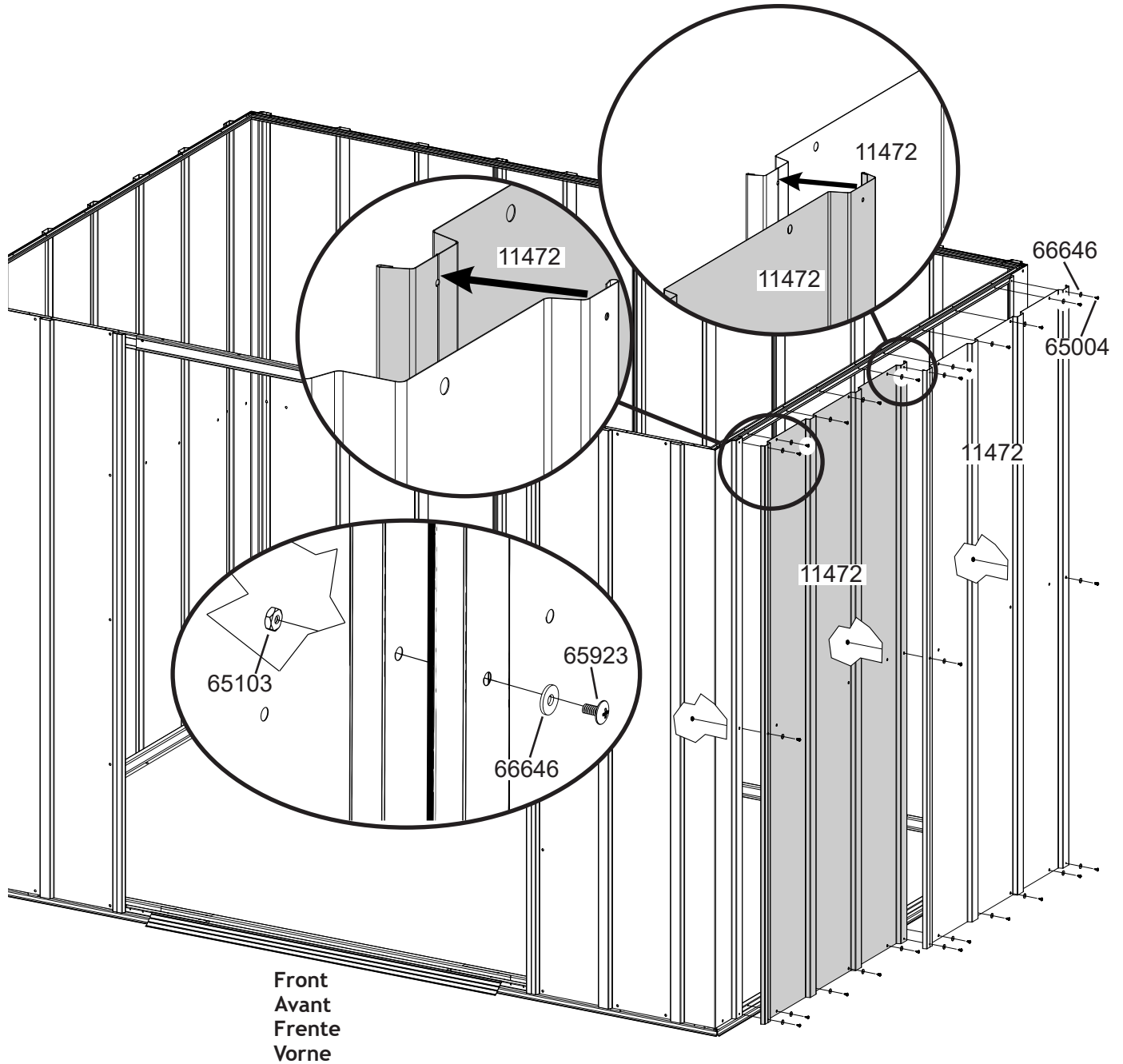
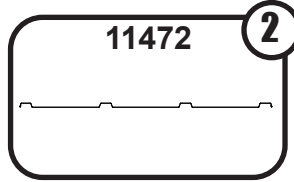
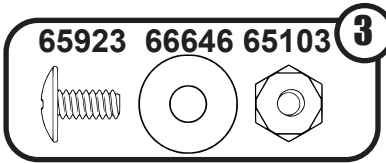
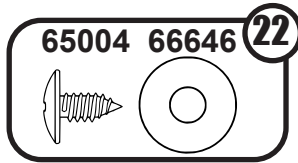

6: DOOR JAMB

JAMBAGE DE PORTE
JAMBA DE LA PUERTA TÜRPFOSTEN

25HY

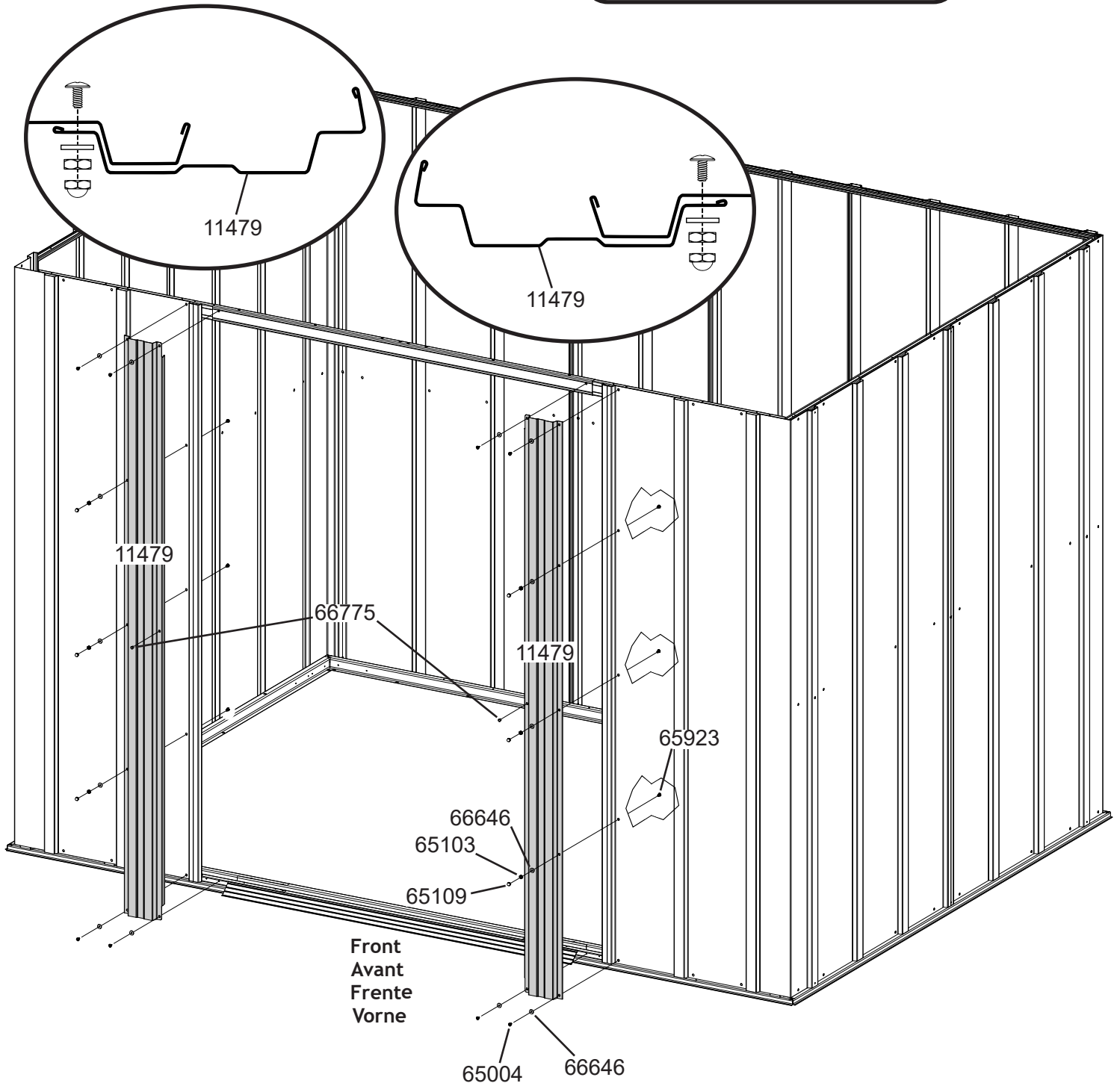
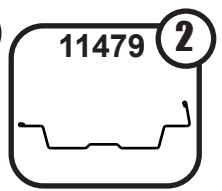
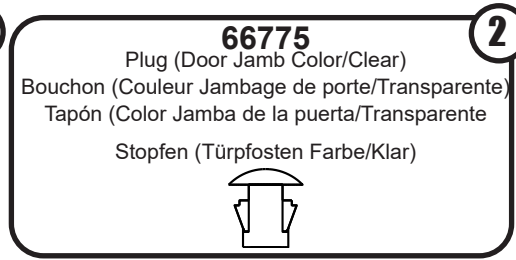
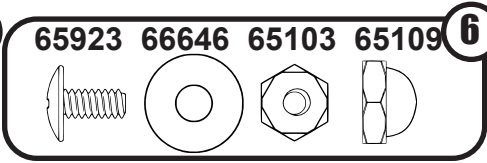
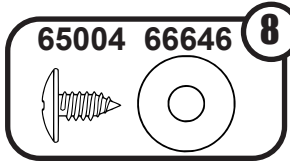

7: WALL CHANNEL

LONGERON DE MUR
CANALETA DE LA PARED WAND VERSTREBUNG

26HY

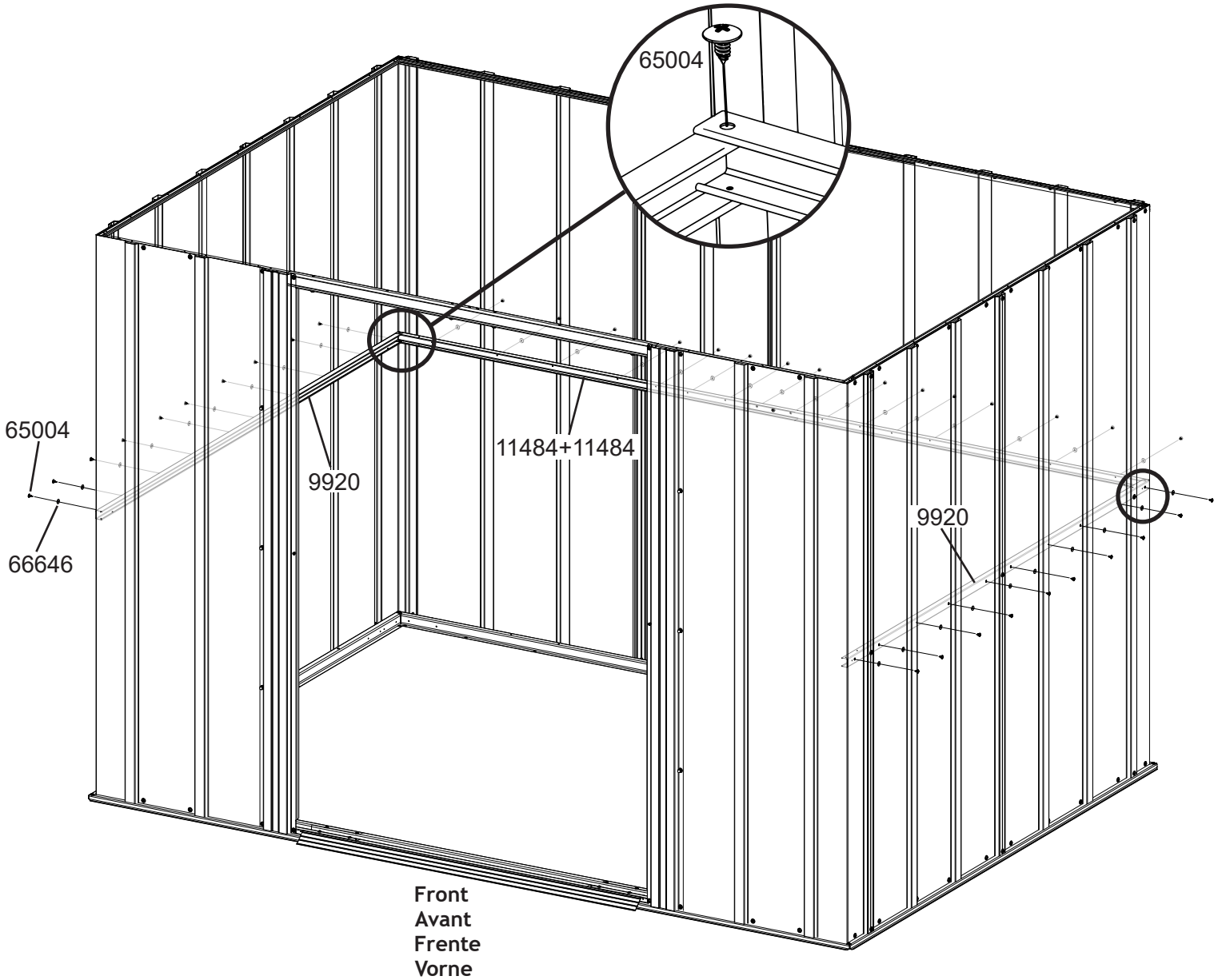
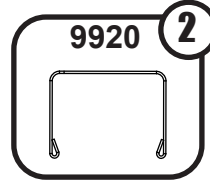
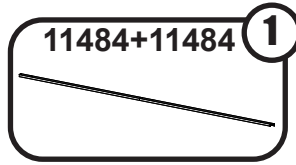
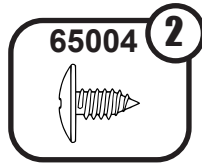
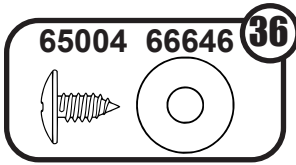

8: GABLES

PIGNON
GABLETE GIEBEL

27HY

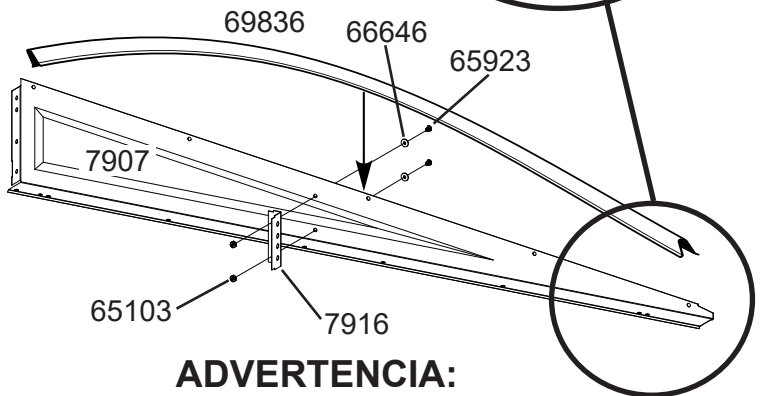
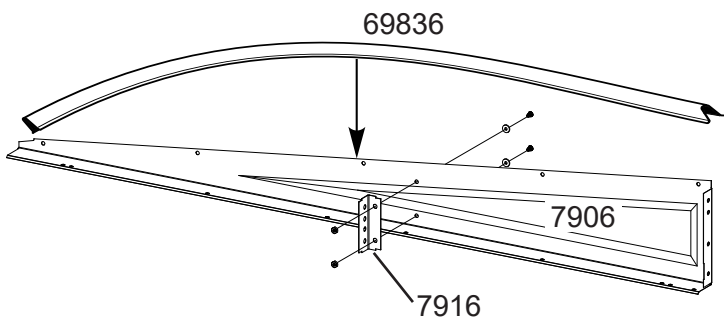
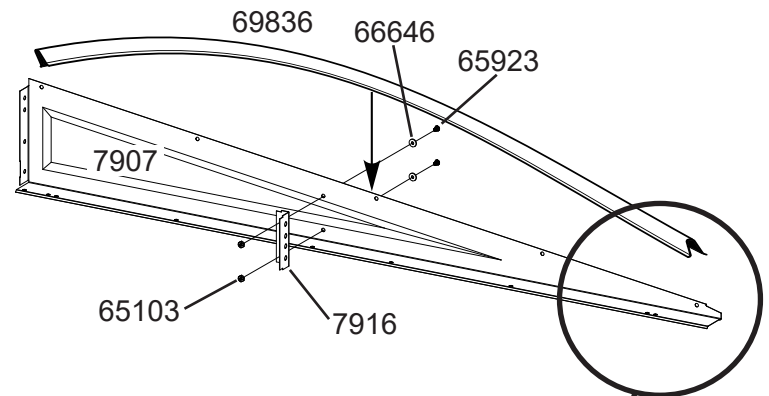
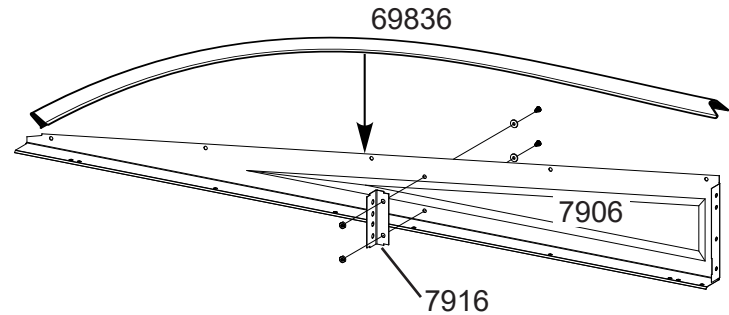
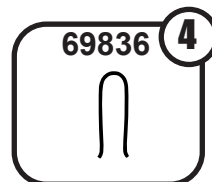
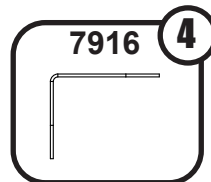
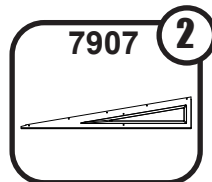
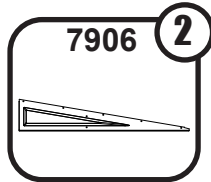
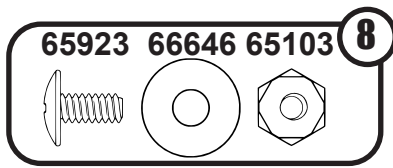

CAUTION:

To avoid mishap on the sharp edge the edge trim must remain in place on the top edge of the gable until right and left roof panels are in place.

PRUDENCE:

Pour éviter les accidents sur l'arête coupante de la garniture de bord, cette garniture doit rester en place sur le bord supérieur du pignon jusqu'à ce que les panneaux de toit droit et gauche soient en place.

ADVERTENCIA:

Para evitar un accidente en el borde filoso, el recuadro del borde debe quedar en su lugar en el borde superior del frontón hasta que los paneles izquierdo y derecho están colocados.

VORSICHT:

Um Unfälle zu vermeiden, sollte die scharfe Kante der Randleiste auf der oberen Kante des Giebels verbleiben, bis die rechten und linken Dachpaneelen angebracht sind.

8: GABLES

PIGNON
GABLETE GIEBEL

28HY

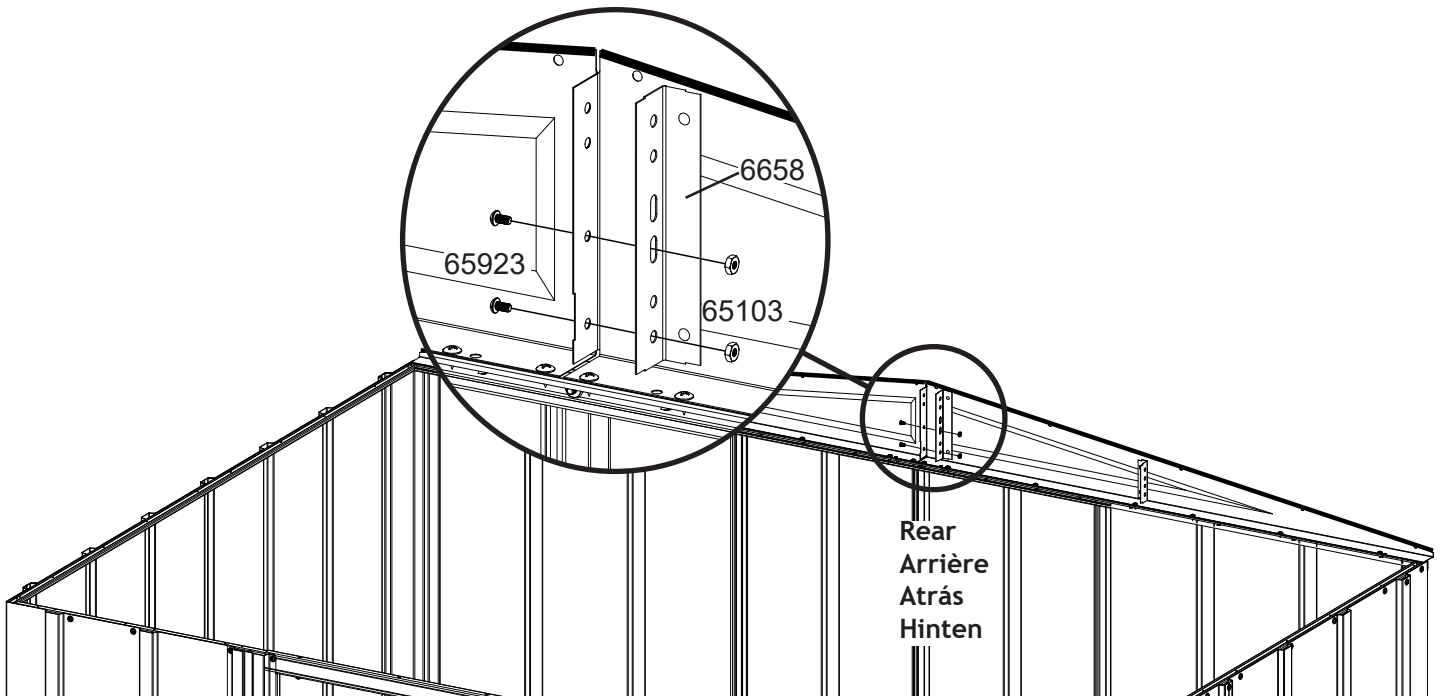
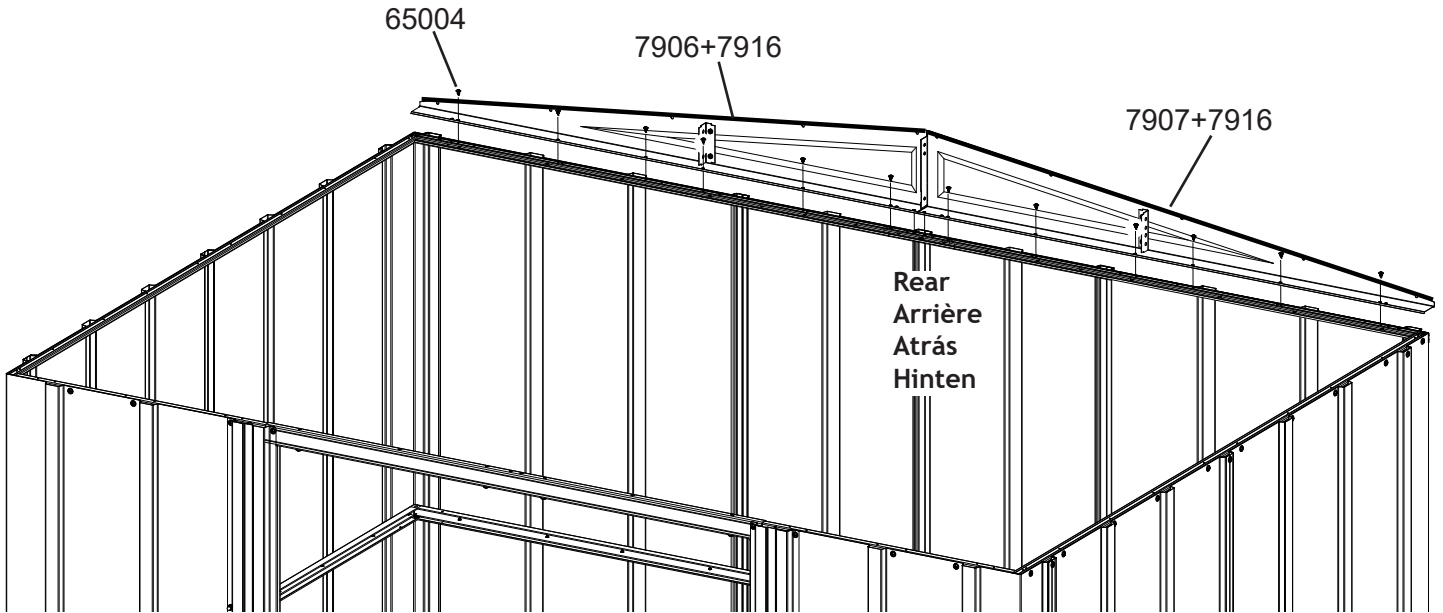
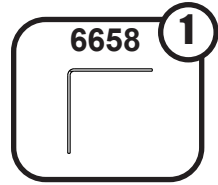
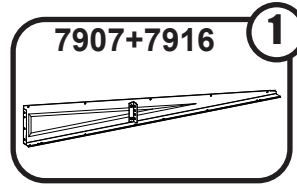
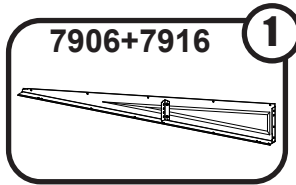
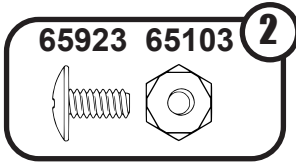
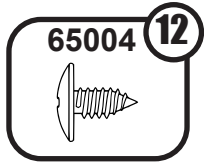

8: GABLES

PIGNON
GABLETE GIEBEL

29HY

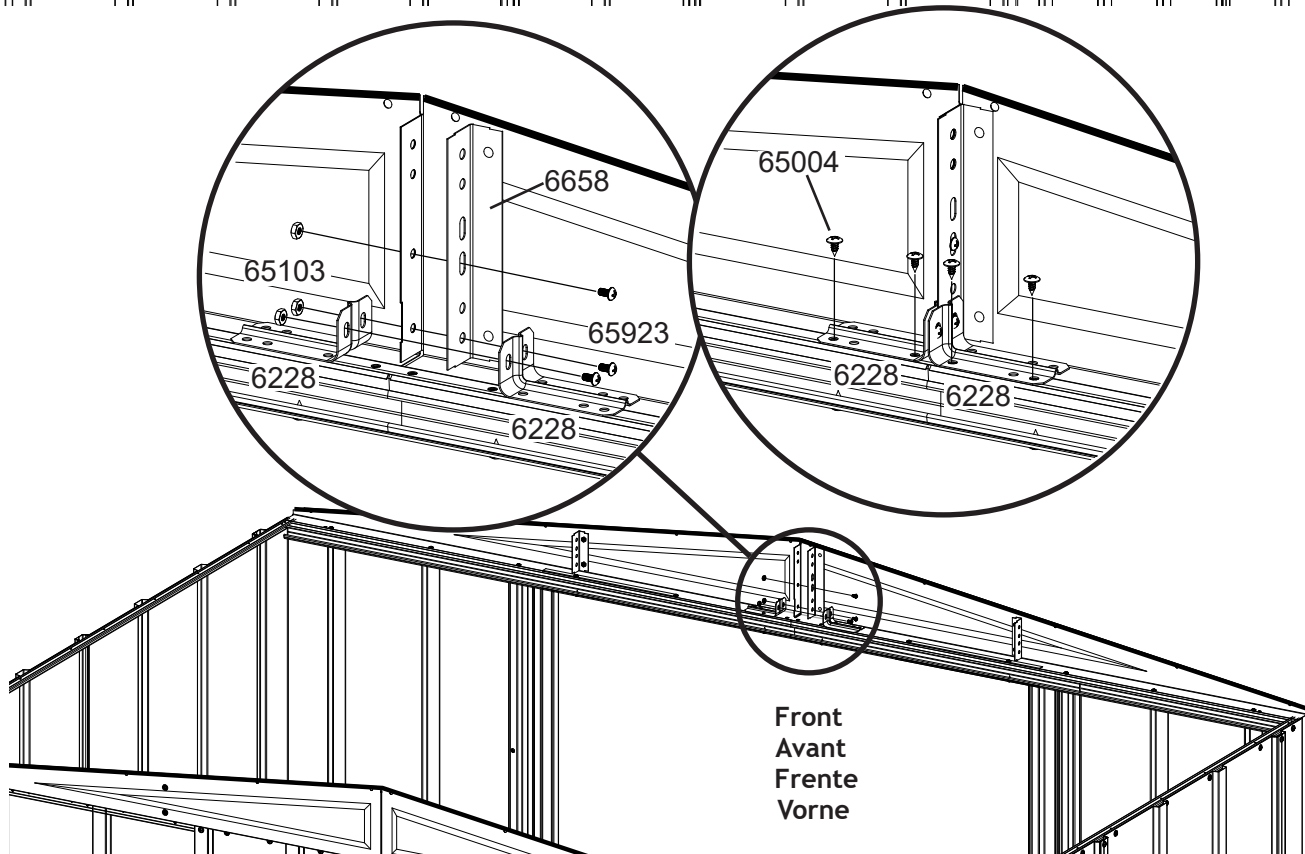
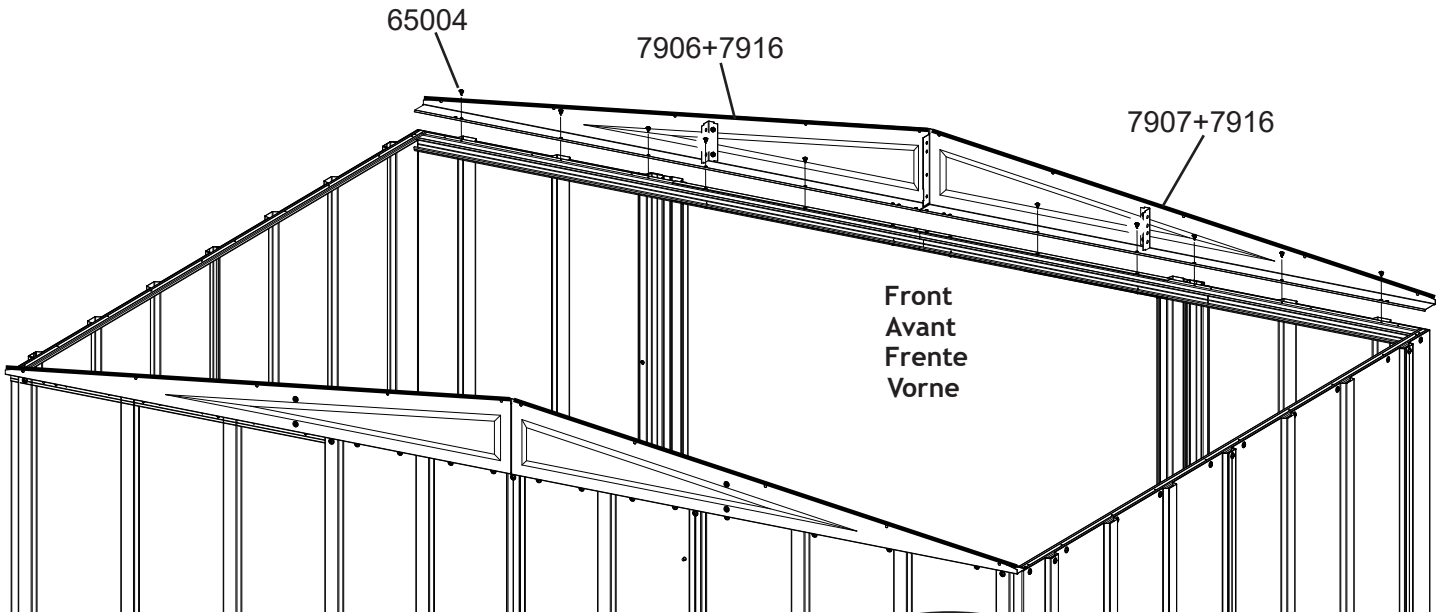
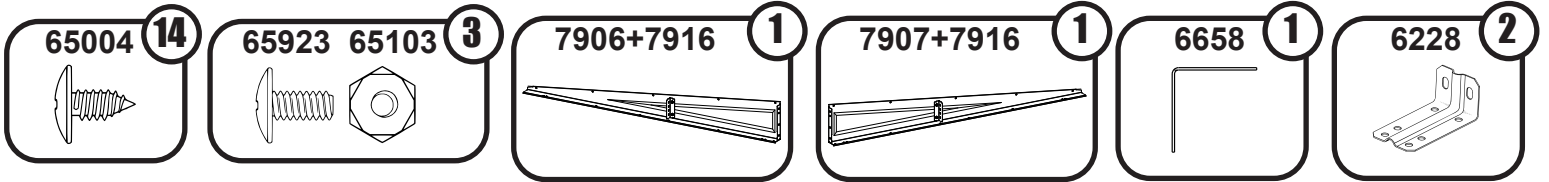

9: ROOF BEAMS

POUTRE DE TOIT
VIGA DEL TECHO DACHTRÄGER

30HY

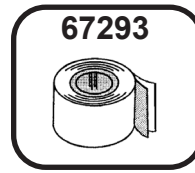
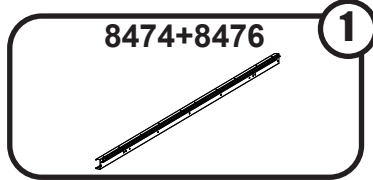
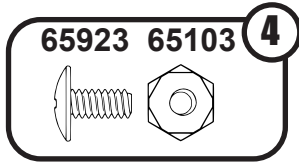

Top View of Gables
Vue de dessus du pignon
Vista superior de gabletes
Draufsicht auf die Giebel

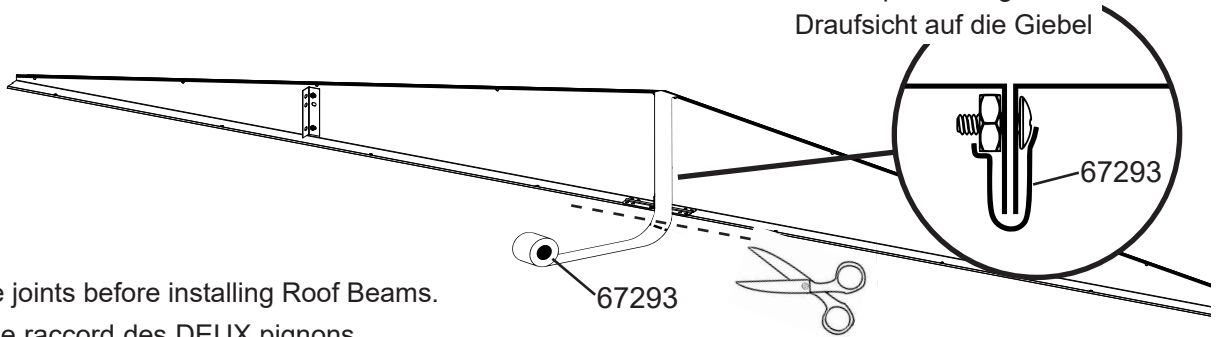

Tape BOTH Gable joints before installing Roof Beams.

Couvrir de ruban le raccord des DEUX pignons avant de poser les poutres du toit.

Coloque cinta adhesiva en AMBAS juntas del gablete antes de instalar las vigas del techo.

Kleben Sie BEIDE Giebelverbindungen zusammen, bevor Sie die Dachbalken montieren.

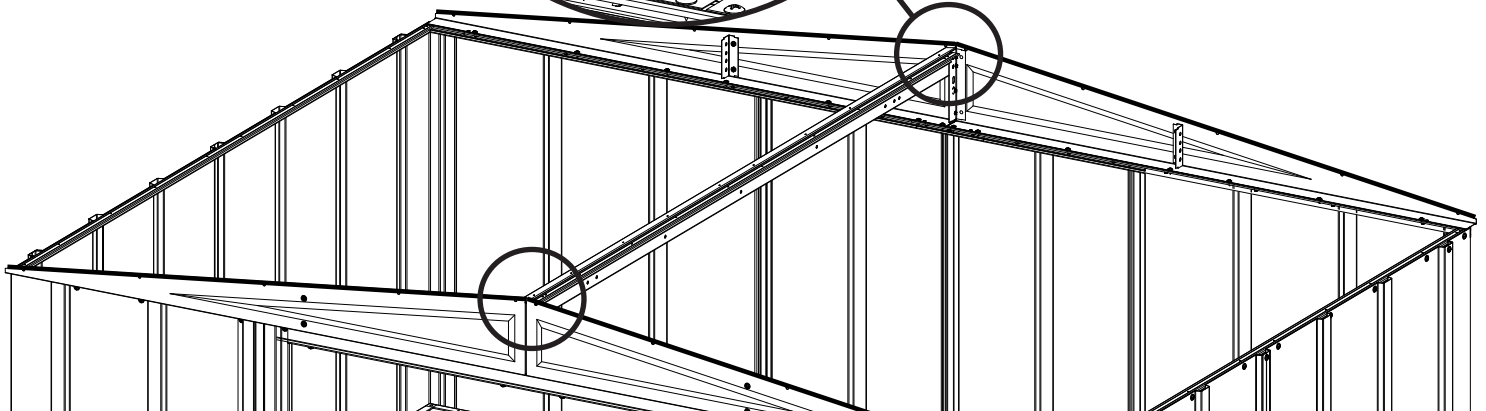
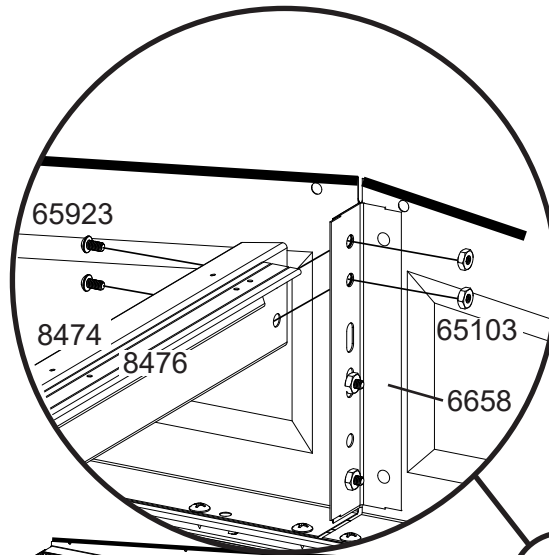

9: ROOF BEAMS

POUTRE DE TOIT
VIGA DEL TECHO DACHTRÄGER

31HY

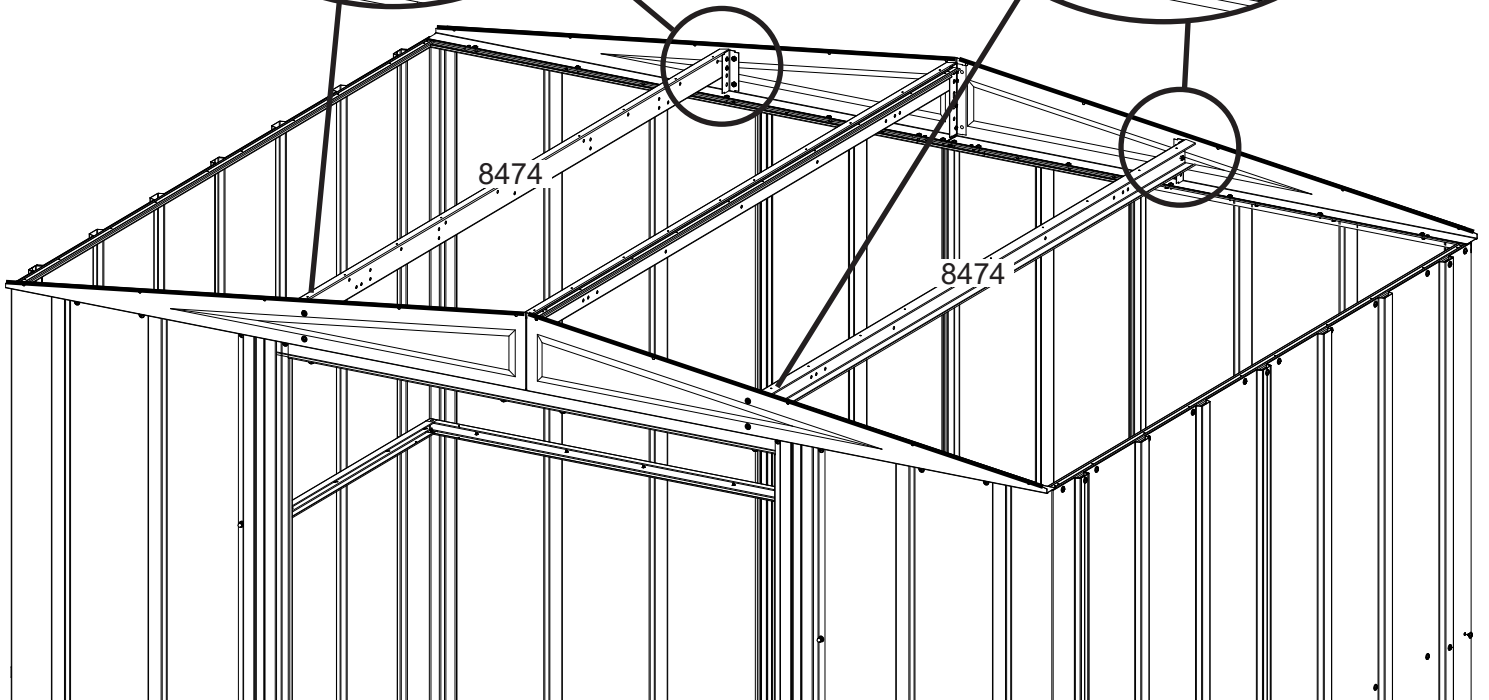
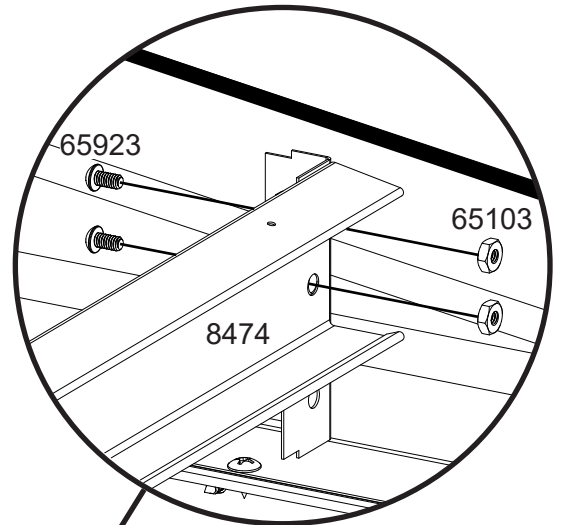
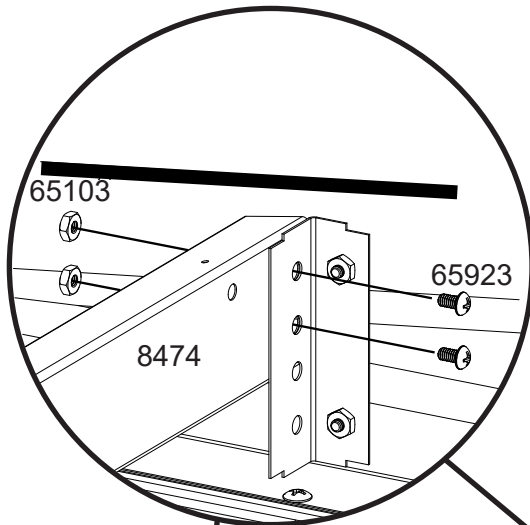
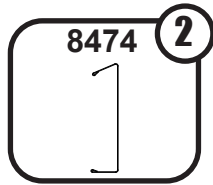
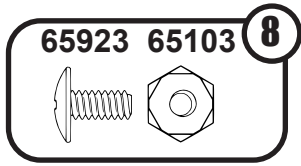

10: ROOF PANELS

PANNEAU DE TOIT
PANEL DEL TECHO DACHBLECH

32HY

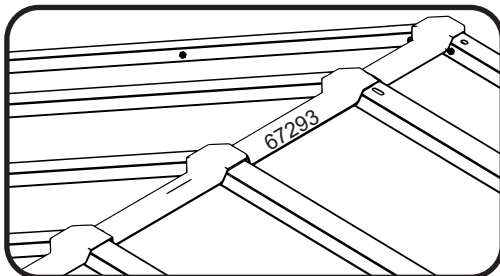
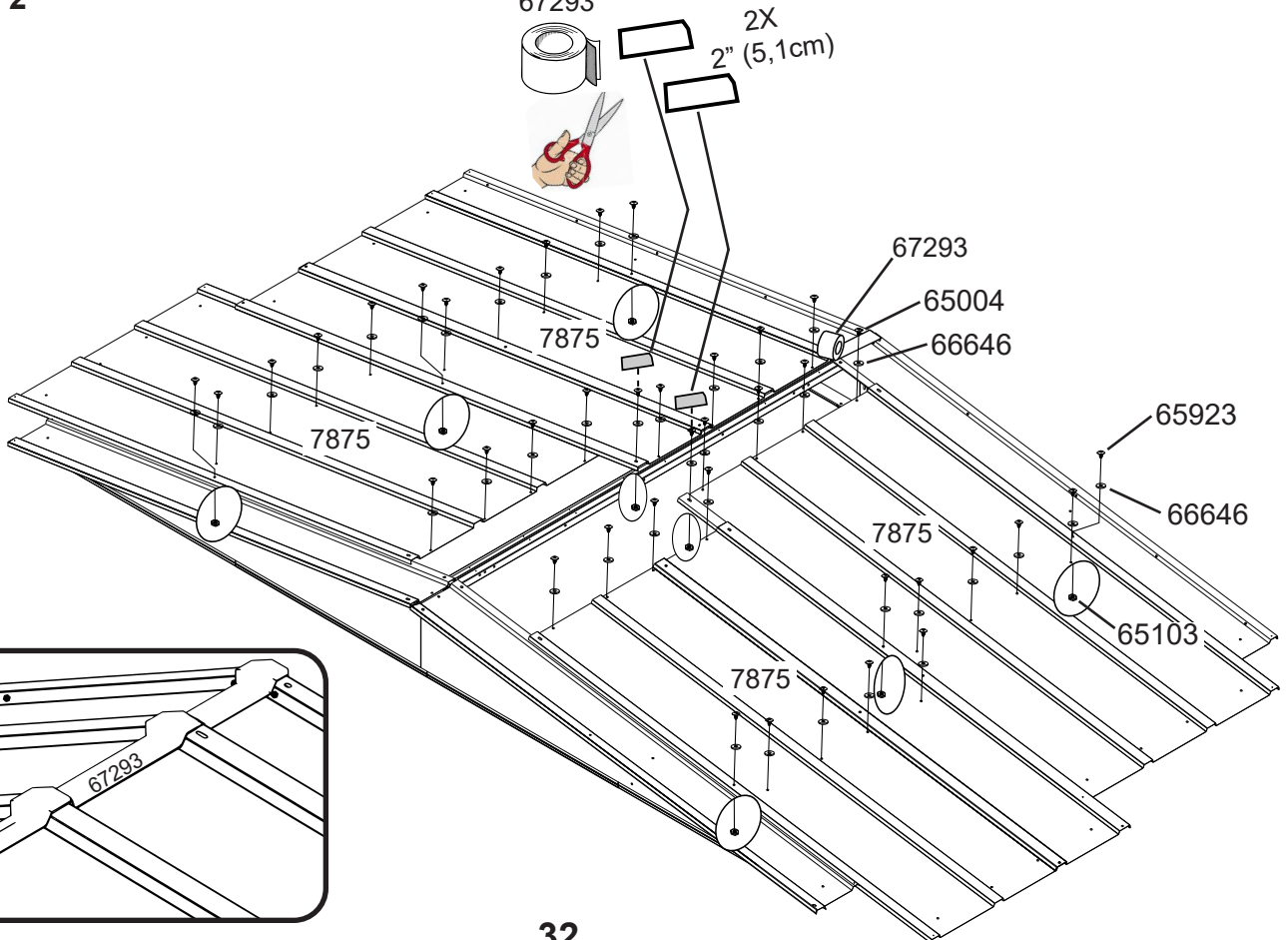
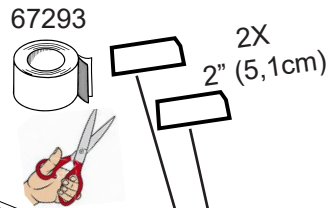
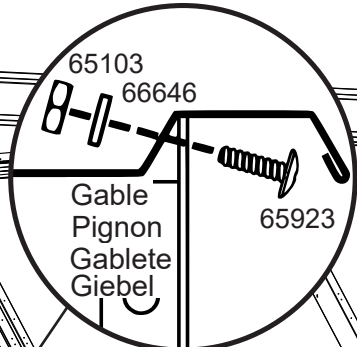
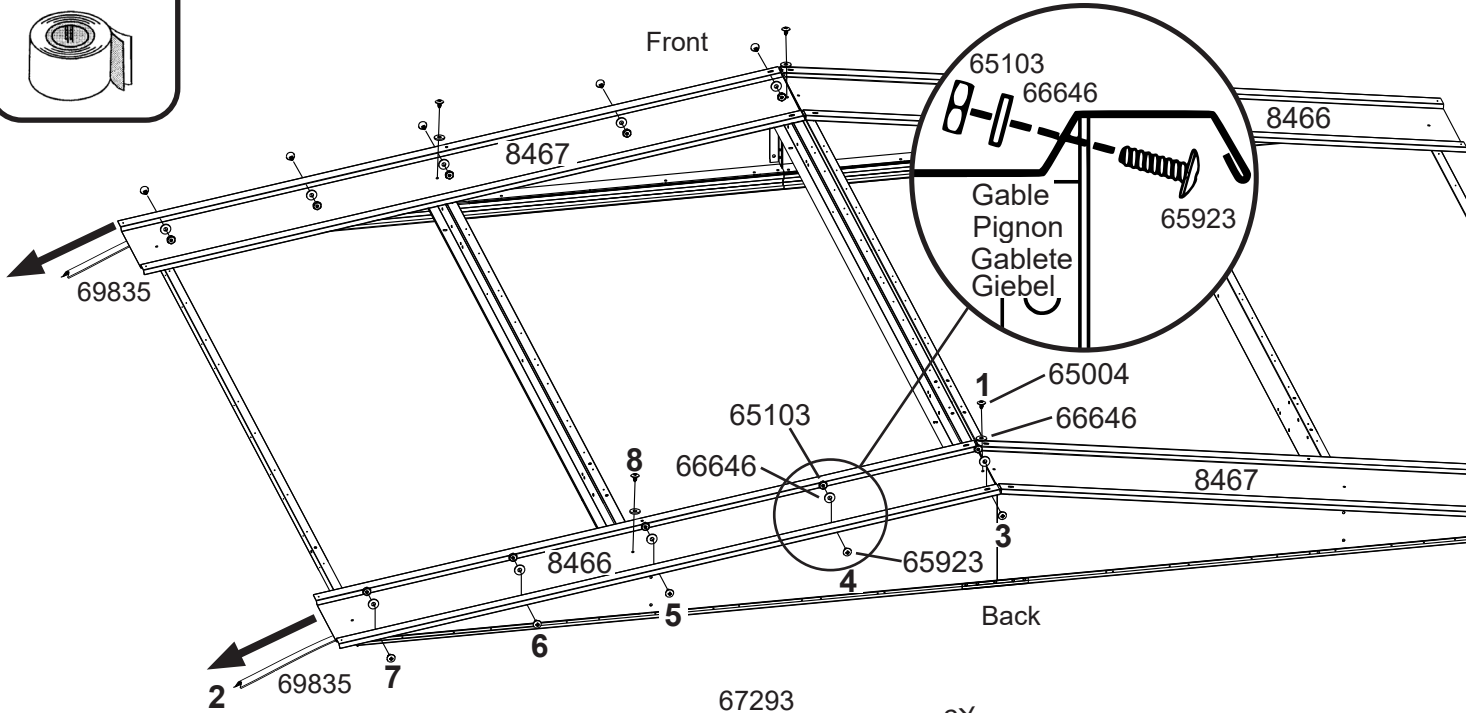
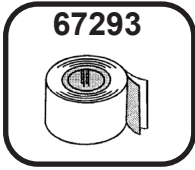
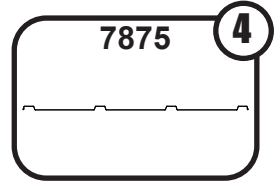
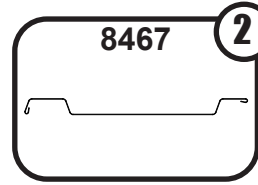
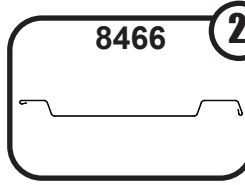
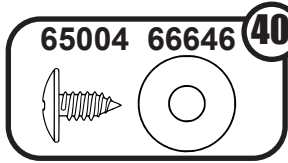
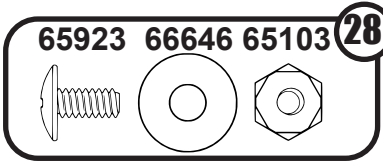

10: ROOF PANELS

PANNEAU DE TOIT
PANEL DEL TECHO DACHBLECH

33HY

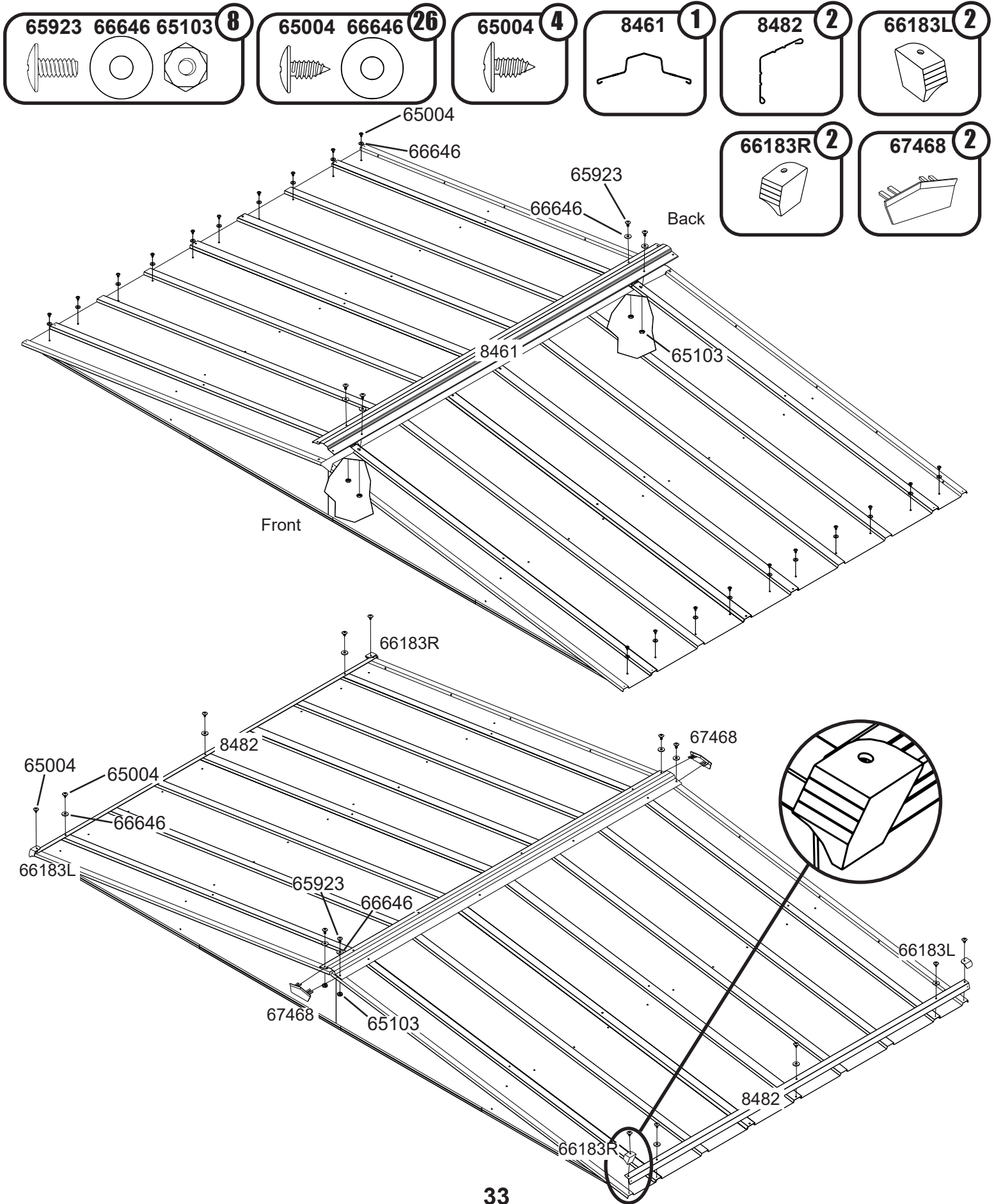

11: DOOR ASSEMBLY

PORTE ASSEMBLÉE
ENSAMBLAJE DE LA PUERTA MONTAGE DER TÜR

34HY

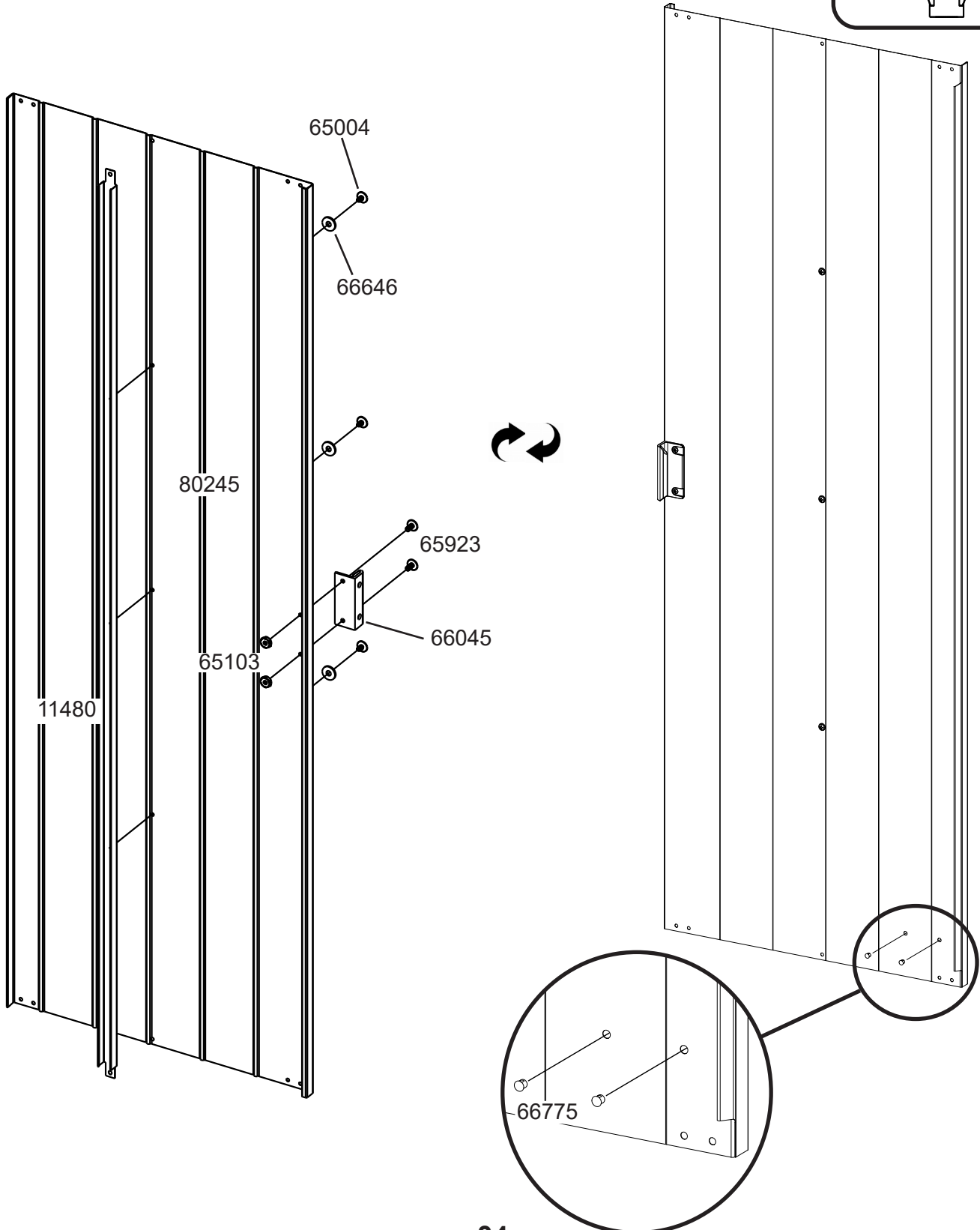
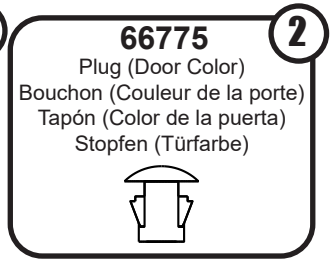
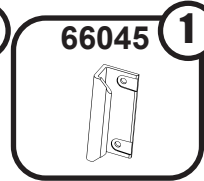
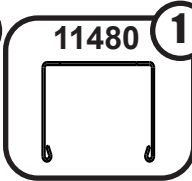
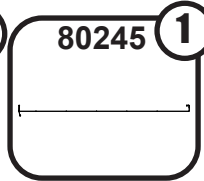
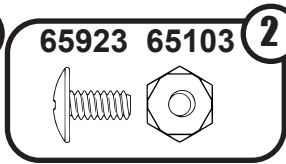
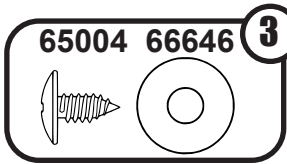

11: DOOR ASSEMBLY

PORTE ASSEMBLÉE
ENSAMBLAJE DE LA PUERTA MONTAGE DER TÜR

35HY

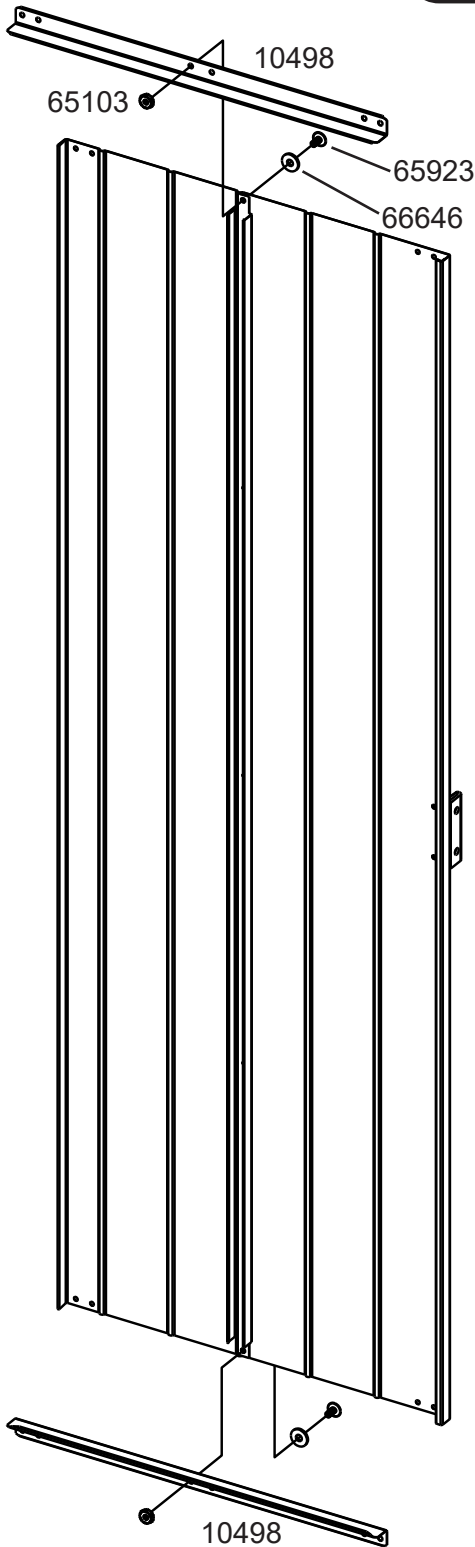
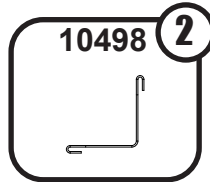
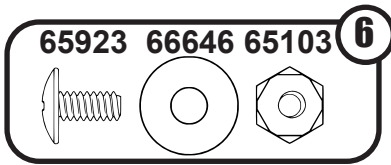

Right Door Assembly
Ensemble de porte droite
Ensamblaje de la puerta derecha
Montage der rechten Tür

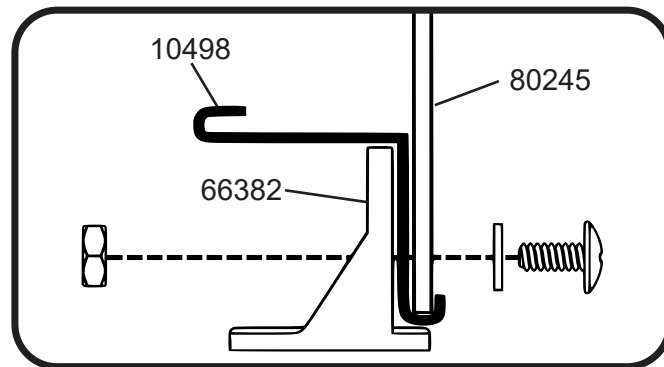
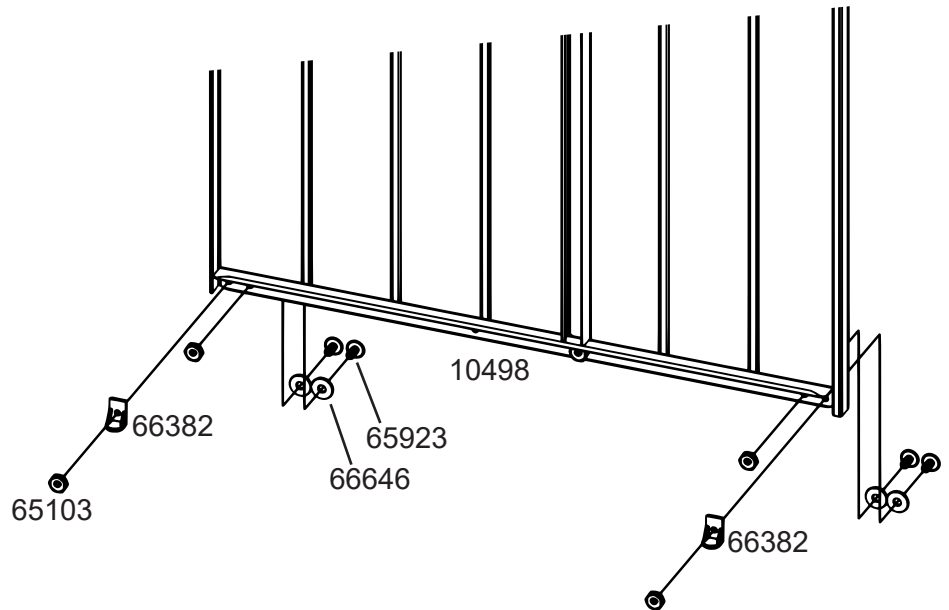

11: DOOR ASSEMBLY

PORTE ASSEMBLÉE
ENSAMBLAJE DE LA PUERTA MONTAGE DER TÜRE

36HY

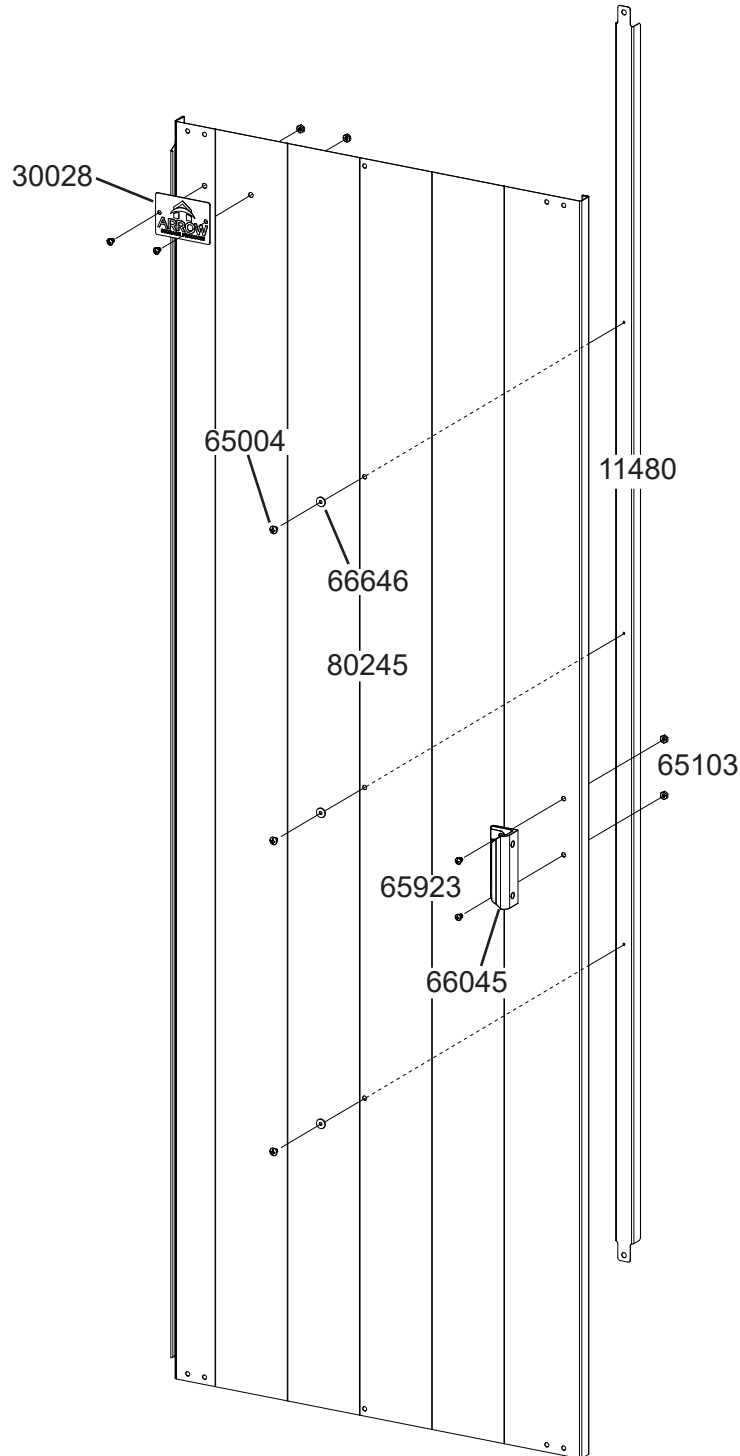
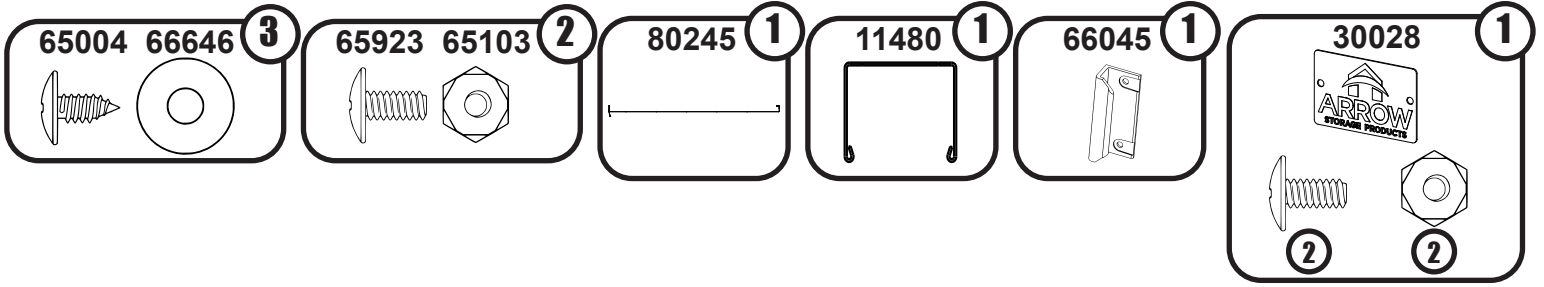

11: DOOR ASSEMBLY *PORTE ASSEMBLÉE* *ENSAMBLAJE DE LA PUERTA MONTAGE DER TÜRE*

37HY

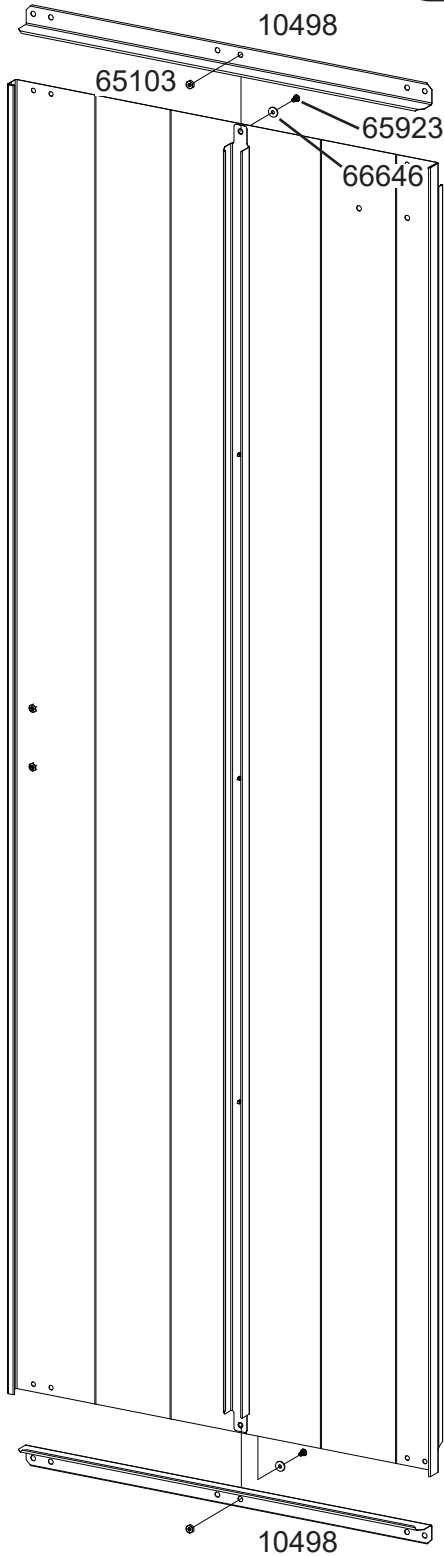
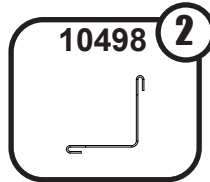
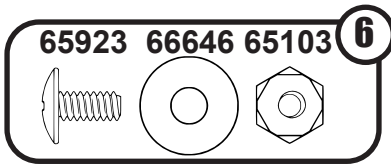

Left Door Assembly
Ensemble de porte gauche
Ensamblaje de la puerta izquierdo
Montage der linken Tür

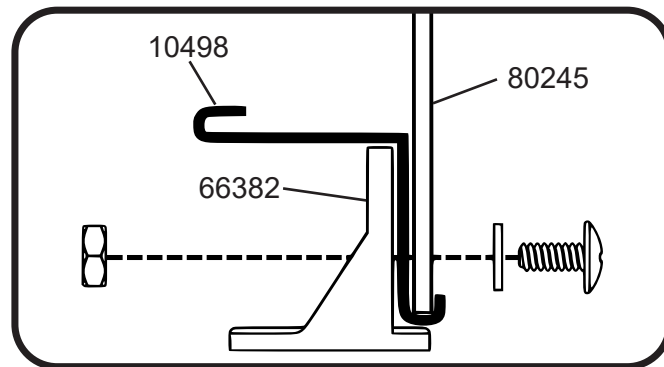
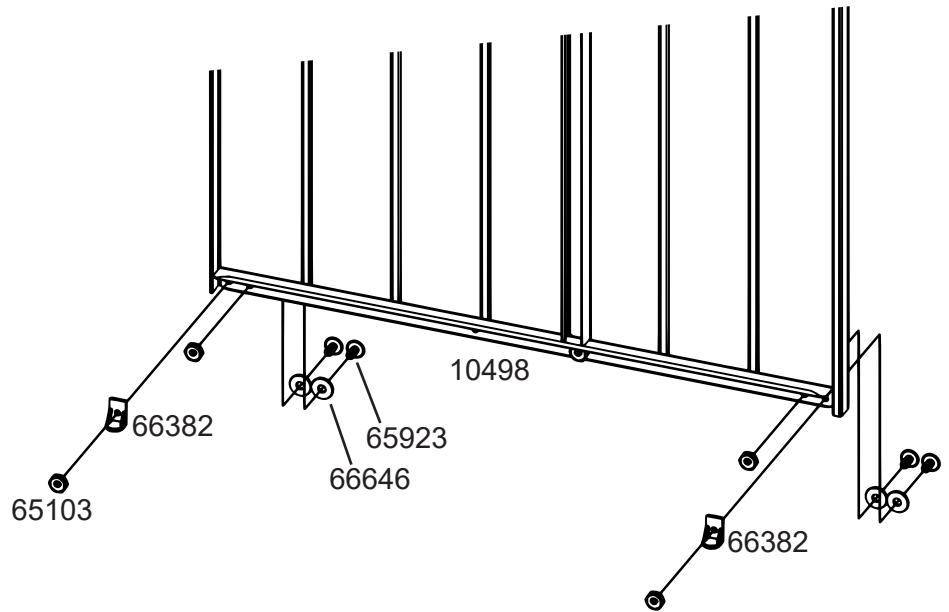

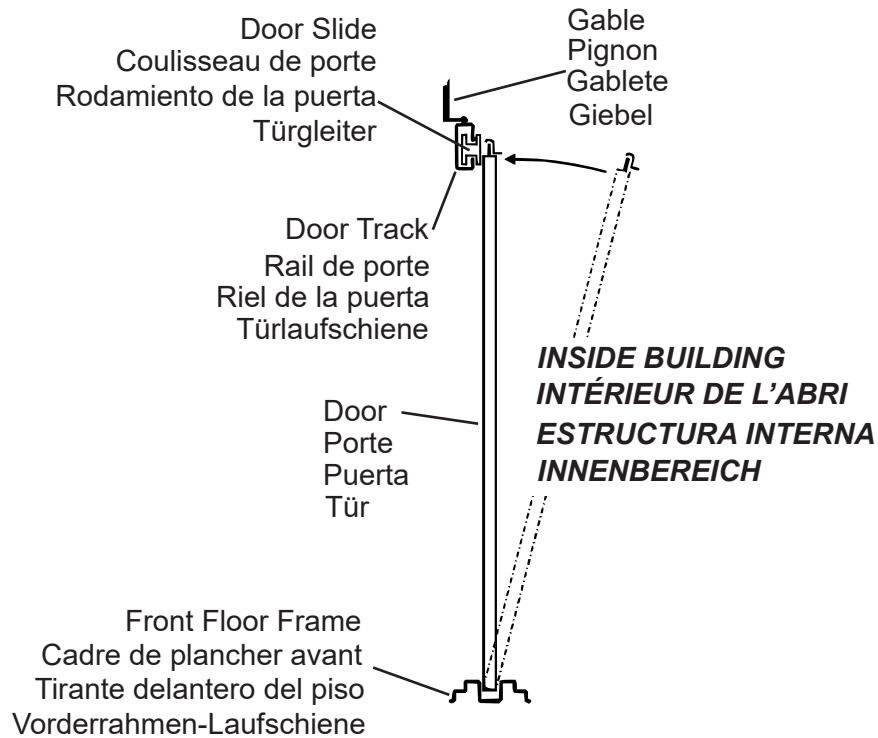
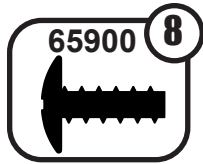

Door Adjustment Réglage de la porte Ajuste de la puerta Ausrichtung der Türe

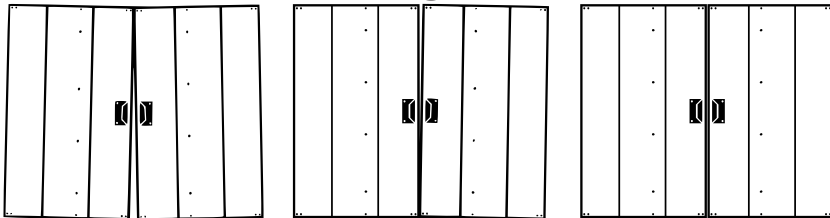
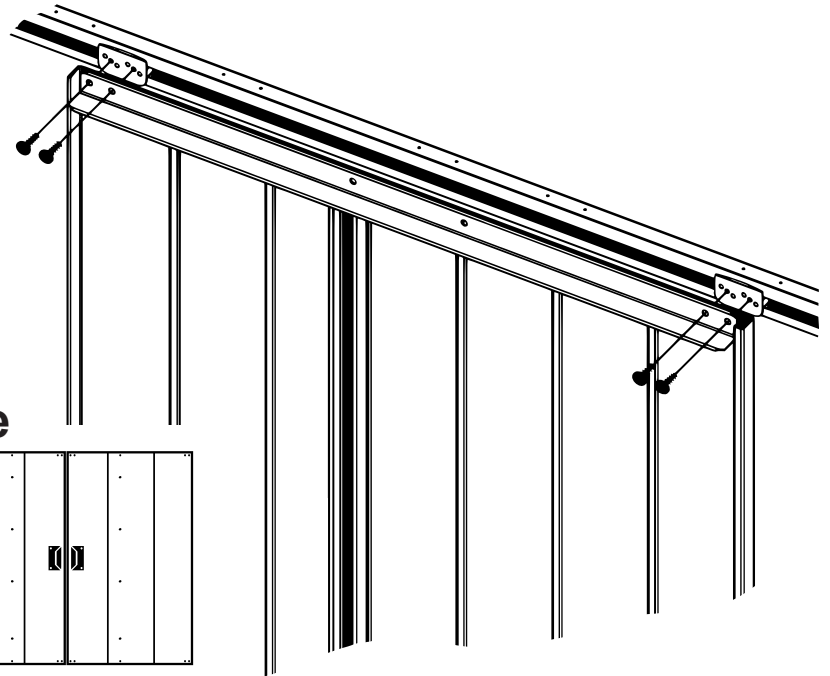

If Doors do not align, raise or lower one side of the Door by placing the Door screws through a different set of holes in the Door Slide.

Si les portes ne sont pas alignées, relever ou abaisser l'un des côtés de la porte en plaçant les vis de porte à travers un jeu de trous différents dans le coulisseau.

Si las puertas no se alinean, eleve o baje un lado e la puerta colocando los tornillos de la puerta por un grupo diferente de orificios en el rodamiento de la puerta.

Falls die Türen nicht richtig ausgerichtet sind, können Sie eine Seite der Tür anheben oder absenken, indem Sie die Türschrauben in den anderen Bohrungen des Türschlittens anbringen.

*** IMPORTANT ***

- *If you have swing doors, they must hang and swing level before anchoring building.*
- *Anchor your building at this time. Use appropriate 1/4"(6mm) X 1 1/2"(38,1mm) length hardware.*
- *Please take a moment to ensure that the building is installed in accordance with these instructions and with all applicable regulations.*
- *The entire floor frame MUST be securely anchored once the building is erected.*

*** IMPORTANT ***

- *Si l'abri comporte des portes battantes, vérifier qu'elles sont accrochées de niveau et pivotent librement avant d'ancrer l'ouvrage.*
- *Ancrez votre bâtiment en ce moment. Utilisez une longueur appropriée de 1/4 po (6 mm) X 1 1/2 po (38,1 mm) Matériel.*
- *Veiller à bien s'assurer que l'abri est installé conformément aux présentes instructions et à toute la réglementation en vigueur.*
- *Le cadre de plancher entier doit IMPÉRATIVEMENT être solidement ancré une fois que l'abri est assemblé.*

*** IMPORTANTE ***

- *Si tiene puertas vaivén, estas deben colgar y moverse en forma pareja antes de sujetar el cobertizo.*
- *Ancle su edificio en este momento. Use una herramienta apropiada de 1/4 "(6 mm) X 1 1/2" (38,1 mm) de longitud.*
- *Dedique unos minutos a asegurarse de que la estructura está instalada de acuerdo con estas instrucciones y con las reglamentaciones vigentes.*
- *Se DEBE anclar todo el tirante del piso cuando la estructura está erguida.*

WICHTIG

- *Wenn Sie Schwingtüren haben, müssen diese sauber hängen und schwingen, bevor der Schuppen verankert wird.*
- *Verankern Sie Ihr Gebäude zu diesem Zeitpunkt. Verwenden Sie angemessene Teile der Länge 1/4"(6mm) X 1 1/2" (38,1mm).*
- *Bitte überprüfen Sie noch einmal, ob der Schuppen im Einklang mit dieser Anleitung und mit allen geltenden Vorschriften aufgestellt wurde.*
- *Nach Aufstellung des Geräteschuppens MUSS der gesamte Bodenrahmen sicher verankert werden.*

